

\*LAST UPDATED 03/11/25

First Name: \_\_\_\_\_ Last Name: \_\_\_\_\_

Customer Signature: \_\_\_\_\_ Date: \_\_\_\_\_

Sales Person Name: \_\_\_\_\_

Sale Order Number: \_\_\_\_\_

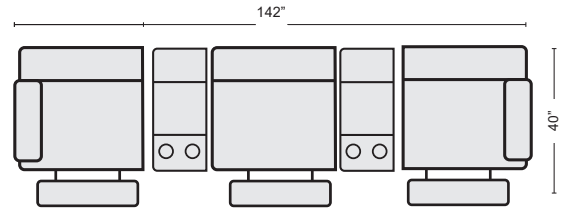

**GREY 5 PC POWER RECLINING CONSOLE  
LOVESEAT W/ POWER HEADR** QTY \_\_\_\_  
KIT- # 269749 \$3,000.00

**BROWN 5 PC POWER RECLINING CONSOLE  
LOVESEAT W/ POWER HEADR** QTY \_\_\_\_  
KIT- # 299281 \$3,000.00

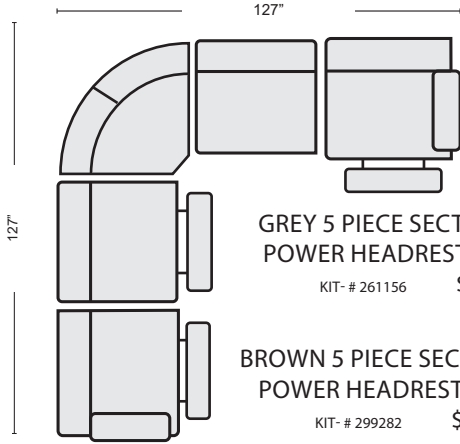

**GREY 5 PIECE SECTIONAL WITH  
POWER HEADREST & LUMBAR** QTY \_\_\_\_  
KIT- # 261156 \$3,195.00

**BROWN 5 PIECE SECTIONAL WITH  
POWER HEADREST & LUMBAR** QTY \_\_\_\_  
KIT- # 299282 \$3,195.00

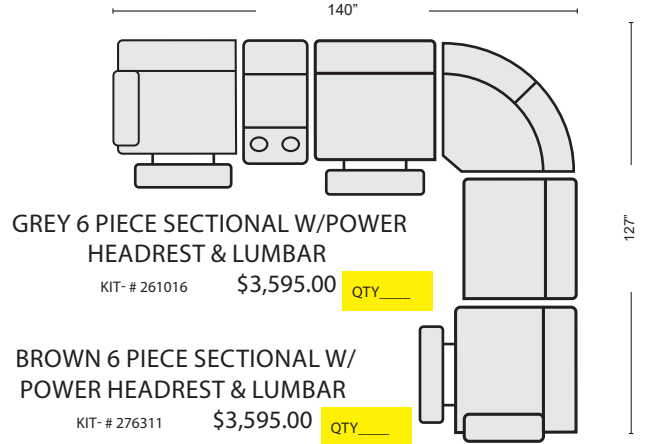

**GREY 6 PIECE SECTIONAL W/POWER  
HEADREST & LUMBAR** QTY \_\_\_\_  
KIT- # 261016 \$3,595.00

**BROWN 6 PIECE SECTIONAL W/  
POWER HEADREST & LUMBAR** QTY \_\_\_\_  
KIT- # 276311 \$3,595.00

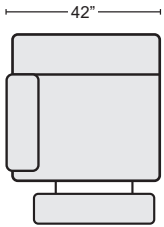

**GREY LAF POWER RECLINER W/PWR  
HEADREST & LUMBAR** QTY \_\_\_\_  
#261014 \$800.00

**BROWN LAF POWER RECLINER W/PWR  
HEADREST & LUMBAR** QTY \_\_\_\_  
#276309 \$800.00

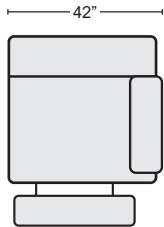

**GREY RAF POWER RECLINER W/PWR  
HEADREST & LUMBAR** QTY \_\_\_\_  
#261015 \$800.00

**BROWN RAF POWER RECLINER W/PWR  
HEADREST & LUMBAR** QTY \_\_\_\_  
#276310 \$800.00

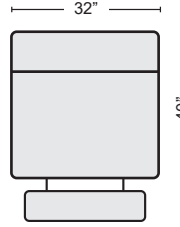

**GREY ARMLESS POWER RECLINER W/  
PWR HEADREST & LUMBAR** QTY \_\_\_\_  
#261012 \$600.00

**BROWN ARMLESS POWER RECLINER W/  
PWR HEADREST & LUMBAR** QTY \_\_\_\_  
#276307 \$600.00

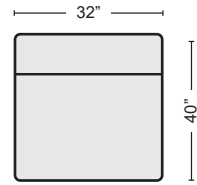

**GREY ARMLESS CHAIR** QTY \_\_\_\_  
#261011 \$350.00

**BROWN ARMLESS CHAIR** QTY \_\_\_\_  
#276306 \$350.00

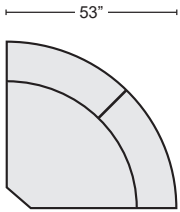

**GREY CORNER WEDGE** QTY \_\_\_\_  
#261017 \$595.00

**BROWN CORNER WEDGE** QTY \_\_\_\_  
#276312 \$595.00

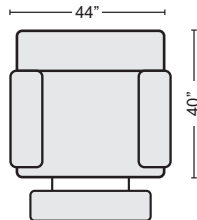

**GREY POWER RECLINER WITH POWER  
HEADREST & LUMBAR** QTY \_\_\_\_  
#261013 \$895.00

**BROWN POWER RECLINER WITH POWER  
HEADREST & LUMBAR** QTY \_\_\_\_  
#276308 \$895.00

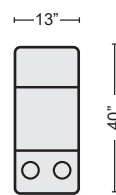

**GREY CONSOLE WITH WIRELESS  
CHARGER** QTY \_\_\_\_  
#261018 \$400.00

**BROWN CONSOLE WITH WIRELESS  
CHARGER** QTY \_\_\_\_  
#276313 \$400.00