



PISMO COLLECTION

LAST UPDATED 02/26/24

First Name: _____ Last Name: _____

Guest Signature: _____ Date: _____

Sales Person Name: _____

Sale Order Number: _____

Initial: _____

FABRIC OPTIONS

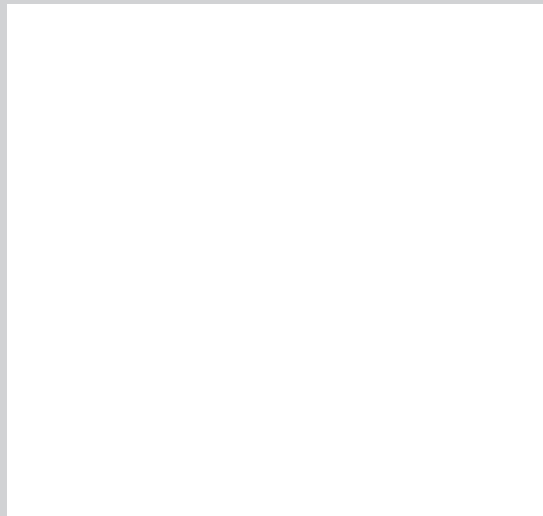

* SECTIONAL PIECES WILL SHIP WITH BRACKETS AND THEY CANNOT BE REQUESTED TO BE MADE WITHOUT BRACKETS. PILLOWS WILL COME IN THE BODY FABRIC.

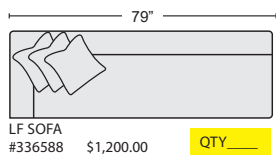
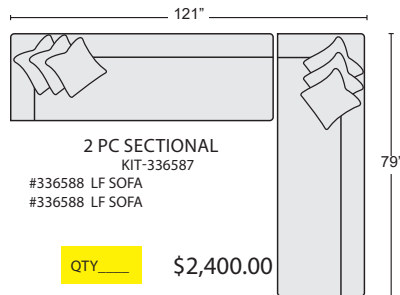
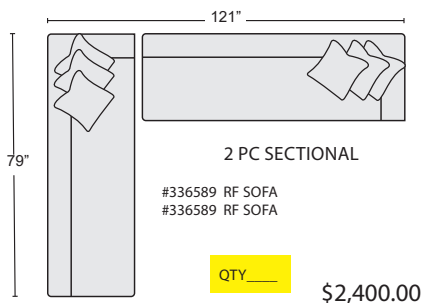

42"

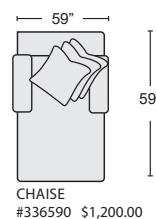
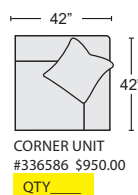
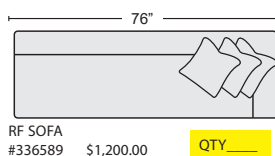

QTY ____