

First Name: _____ Last Name: _____

Customer Signature: _____ Date: _____

Sales Person Name: _____

Sale Order Number: _____

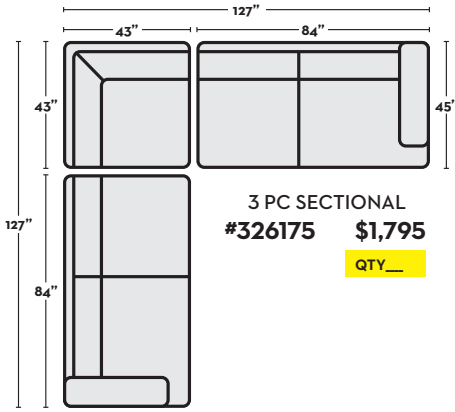

3 PC SECTIONAL
#326175 **\$1,795**
QTY_

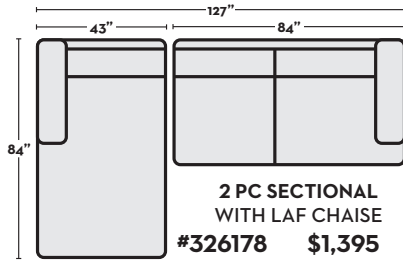

2 PC SECTIONAL WITH LAF CHAISE
#326178 **\$1,395**
QTY_

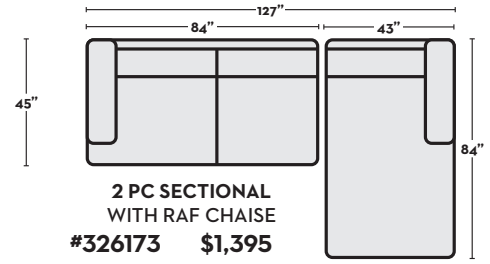

2 PC SECTIONAL WITH RAF CHAISE
#326173 **\$1,395**
QTY_

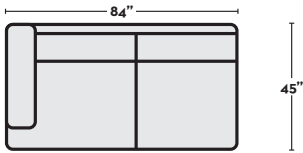

LAF SOFA
#326176 **\$680** QTY_

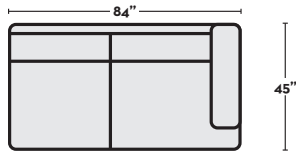

RAF SOFA
#326179 **\$680** QTY_

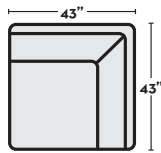

CORNER
#326181 **\$435**
QTY_

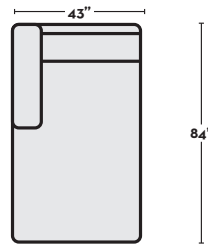

LAF CHAISE
#326170 **\$715**
QTY_

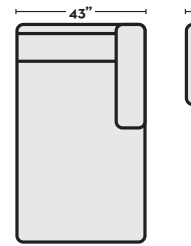

RAF CHAISE
#326171 **\$715**
QTY_

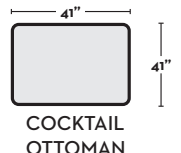

COCKTAIL OTTOMAN
#326180 **\$350**
QTY_