

First Name: \_\_\_\_\_ Last Name: \_\_\_\_\_

Customer Signature: \_\_\_\_\_ Date: \_\_\_\_\_

Sales Person Name: \_\_\_\_\_

Sale Order Number: \_\_\_\_\_

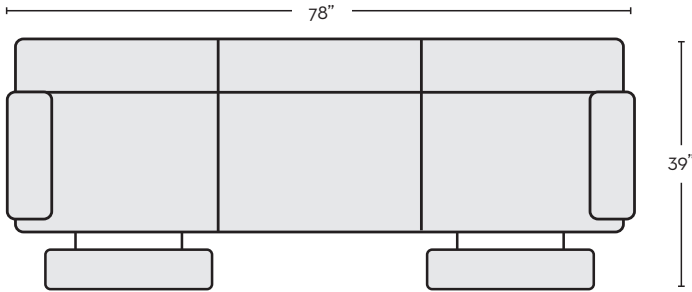

POWER RECLINING SOFA WITH POWER HEADREST & USB  
#328055 \$695.00

QTY\_\_

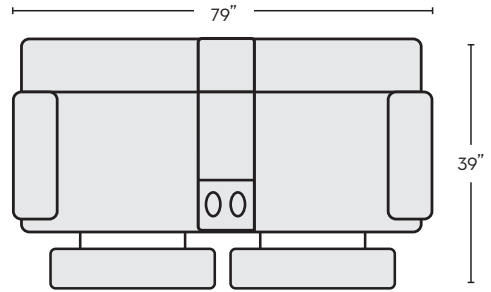

POWER RECLINING CONSOLE LOVESEAT WITH POWER HEADREST & USB  
#328052 \$695.00

QTY\_\_

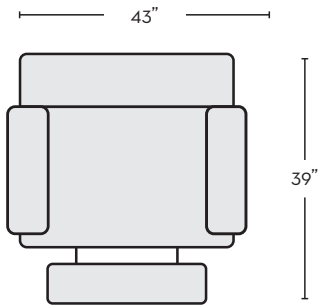

POWER RECLINER WITH POWER HEADREST & USB  
#328051 \$450.00

QTY\_\_