

*LAST UPDATED 08/30/21

First Name: _____ Last Name: _____

Customer Signature: _____ Date: _____

Sales Person Name: _____

Sale Order Number: _____

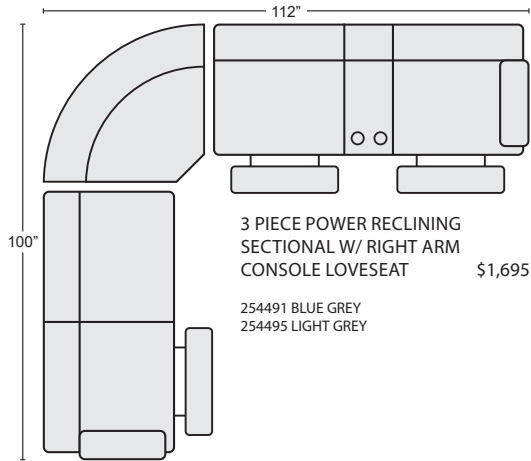

3 PIECE POWER RECLINING SECTIONAL W/ RIGHT ARM CONSOLE LOVESEAT \$1,695
 254491 BLUE GREY
 254495 LIGHT GREY

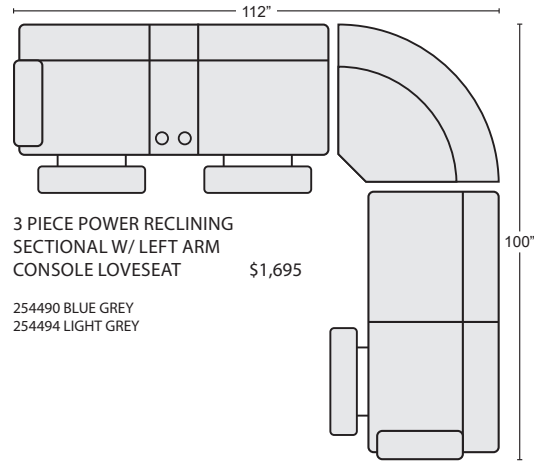

3 PIECE POWER RECLINING SECTIONAL W/ LEFT ARM CONSOLE LOVESEAT \$1,695
 254490 BLUE GREY
 254494 LIGHT GREY

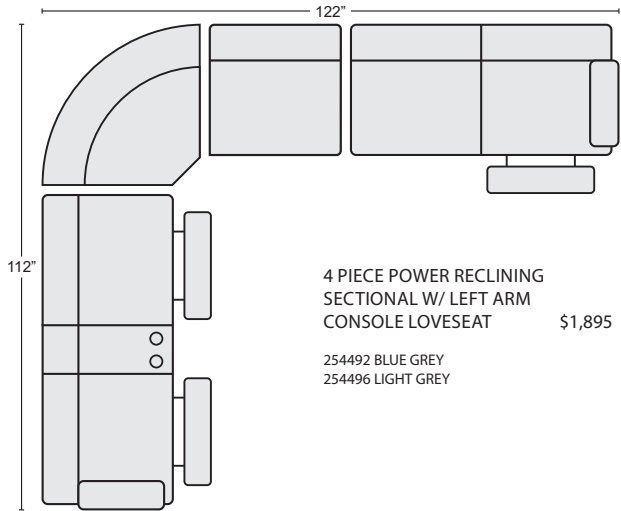

4 PIECE POWER RECLINING SECTIONAL W/ LEFT ARM CONSOLE LOVESEAT \$1,895
 254492 BLUE GREY
 254496 LIGHT GREY

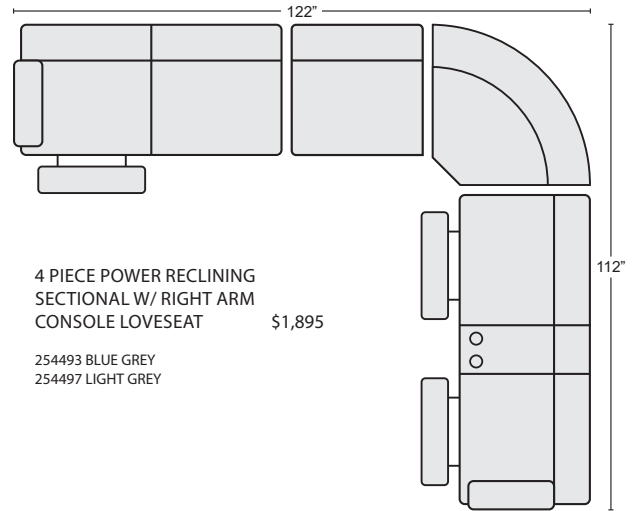

4 PIECE POWER RECLINING SECTIONAL W/ RIGHT ARM CONSOLE LOVESEAT \$1,895
 254493 BLUE GREY
 254497 LIGHT GREY

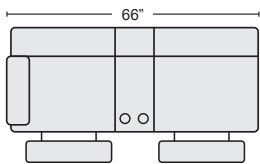

LEFT ARM DUAL POWER CONSOLE LOVESEAT \$745.00
 254505 BLUE GREY
 254504 LIGHT GREY

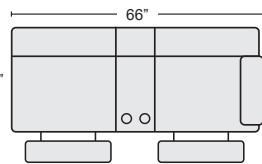

LEFT ARM DUAL POWER CONSOLE LOVESEAT \$745.00
 254507 BLUE GREY
 254506 LIGHT GREY

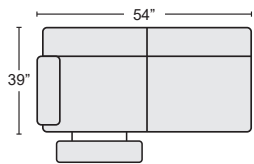

LEFT ARM POWER LOVESEAT \$55.00
 254503 BLUE GREY
 254502 LIGHT GREY

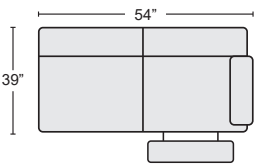

RIGHT ARM POWER LOVESEAT \$550.00
 254501 BLUE GREY
 254500 LIGHT GREY

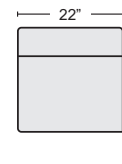

ARMLESS CHAIR \$200.00
 254499 BLUE GREY
 254498 LIGHT GREY

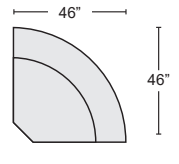

WEDGE \$400.00
 254509 BLUE GREY
 254508 LIGHT GREY