

*LAST UPDATED 01/26/21

First Name: _____ Last Name: _____

Customer Signature: _____ Date: _____

Sales Person Name: _____

Sale Order Number: _____

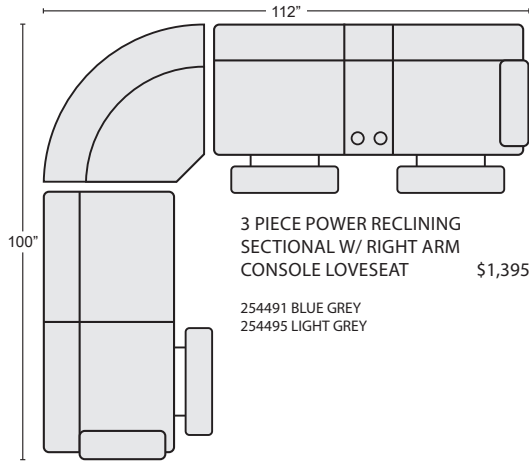

3 PIECE POWER RECLINING SECTIONAL W/ RIGHT ARM CONSOLE LOVESEAT \$1,395
254491 BLUE GREY
254495 LIGHT GREY

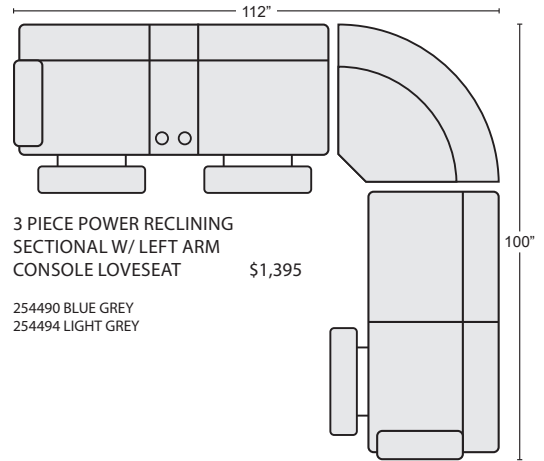

3 PIECE POWER RECLINING SECTIONAL W/ LEFT ARM CONSOLE LOVESEAT \$1,395
254490 BLUE GREY
254494 LIGHT GREY

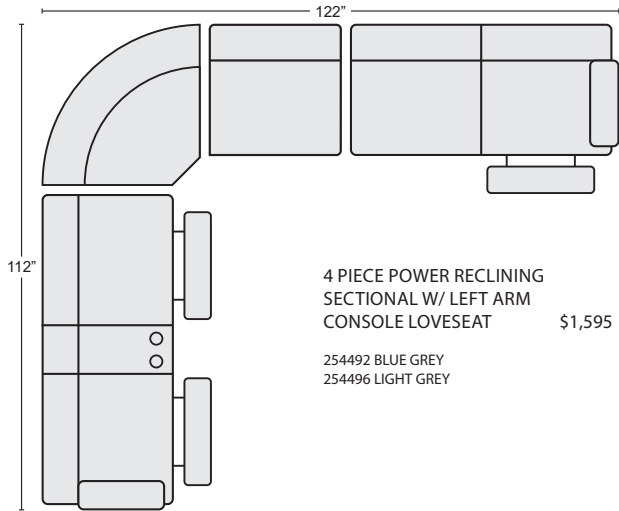

4 PIECE POWER RECLINING SECTIONAL W/ LEFT ARM CONSOLE LOVESEAT \$1,595
254492 BLUE GREY
254496 LIGHT GREY

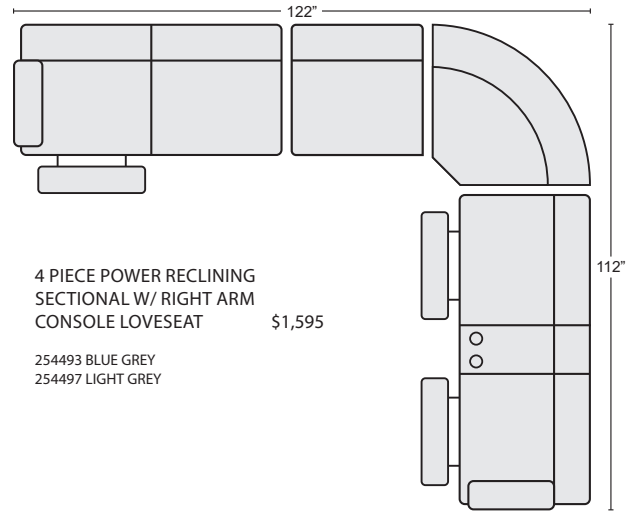

4 PIECE POWER RECLINING SECTIONAL W/ RIGHT ARM CONSOLE LOVESEAT \$1,595
254493 BLUE GREY
254497 LIGHT GREY

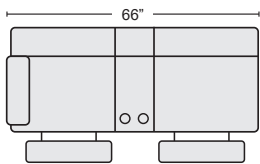

LEFT ARM DUAL POWER CONSOLE LOVESEAT \$620.00
254505 BLUE GREY
254504 LIGHT GREY

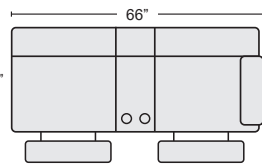

LEFT ARM DUAL POWER CONSOLE LOVESEAT \$620.00
254507 BLUE GREY
254506 LIGHT GREY

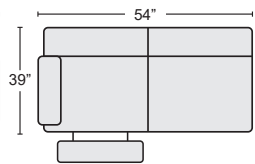

LEFT ARM POWER LOVESEAT \$470.00
254503 BLUE GREY
254502 LIGHT GREY

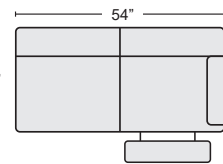

RIGHT ARM POWER LOVESEAT \$470.00
254501 BLUE GREY
254500 LIGHT GREY

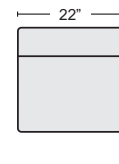

ARMLESS CHAIR \$200.00
254499 BLUE GREY
254498 LIGHT GREY

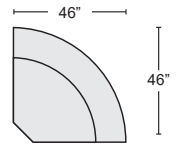

WEDGE \$305.00
254509 BLUE GREY
254508 LIGHT GREY