

First Name: _____ Last Name: _____

Customer Signature: _____ Date: _____

Sales Person Name: _____

Sale Order Number: _____

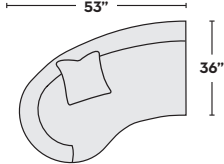
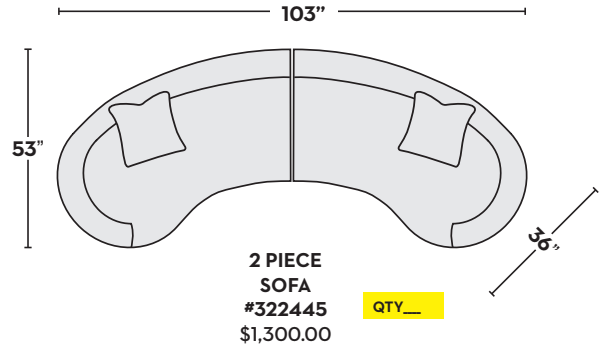
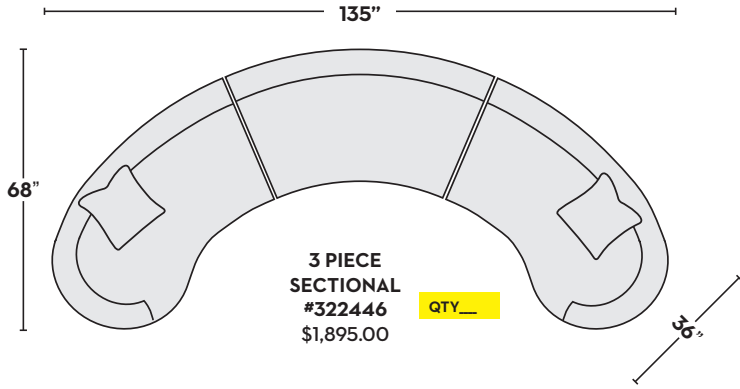

LAF LOVESEAT
#322162 QTY_
\$650.00

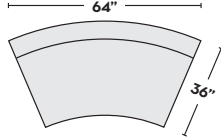

ARMLESS LOVESEAT
#322161 QTY_
\$595.00

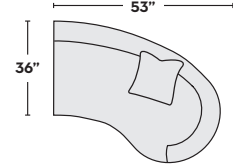

RAF LOVESEAT
#322163 QTY_
\$650.00

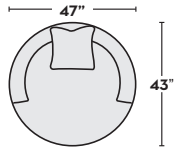

SWIVEL CUDDLER CHAIR
#322443 QTY_
\$795.00

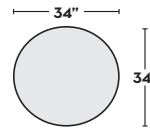

ROUND COCKTAIL OTTOMAN
#322164 QTY_
\$350.00