









LIVING SPACES

A	B8280 - 2 - A	 X 1
B	B8280 - 2 - B	 X 1
C	B8280 - 2 - C	 X 1
D	B8280 - 2 - D	 X 1
E	B8280 - 2 - E	 X 1
F	B8280 - 2 - F	 X 4

NIGHT STAND



B8280 - 2
NIGHT STAND

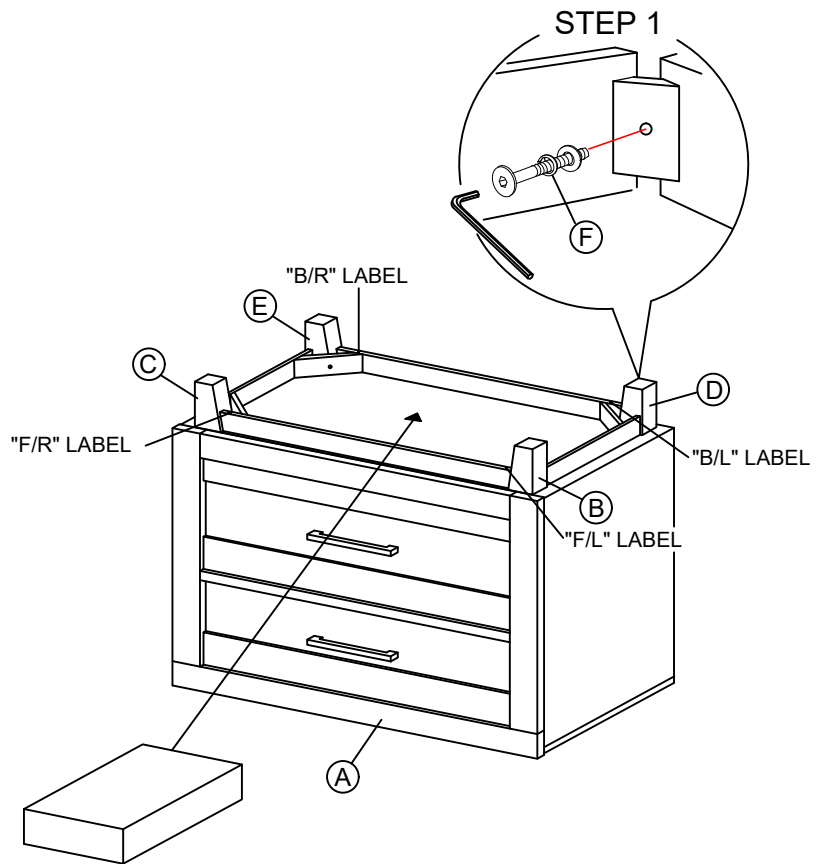

REMARK : 4 PCS LEG INSIDE THE BOX
WHICH IS LOCATED ON THE BOTTOM
PACKING PALLET.

