



MAGNOLIA  
HOME

BY JOANNA GAINES

# ASSEMBLY INSTRUCTIONS

GROUP NO. 60000001 - FARM DR





ITEM NO. 6012103FF - TABLE, TOP - BELFORD DINING FEATHER  
6012101FF - TABLE, BASE - BELFORD DINING FEATHER

## Read instruction carefully prior to assembly.



Thank you for purchasing this quality product. Check carefully for small parts which may come loose during shipment. Remove all components from pack and place top down on soft surface such as carpet or cloth to prevent scratching the finish. Identify and count all parts as specified below.

**It is recommended to use two or more persons during the assembly process.**

### HARDWARE LIST:

No.	Description	Sketch	Size	Qty
A	Allen Bolt		Ø5/16"x25mm	05 pcs
B	Flat Washer		Ø5/16"x19mm	05 pcs
C	Spring Washer		Ø5/16"*10mm	05 pcs
D	Allen Key		4 mm	1 pc

### PARTS LIST:

No.	Description	Sketch	Qty
1	Table Top		1 pc
2	Table Base		1 pc

### Step 1: Assembly the Table Base into the Table Top.

Turn the Table Top (1) upside down. Attach the Table base (2) to the Table Top (1), using Allen Bolts (A), Spring Washer (C) and the Flat Washer (B) as show. Tightly fasten all bolts.

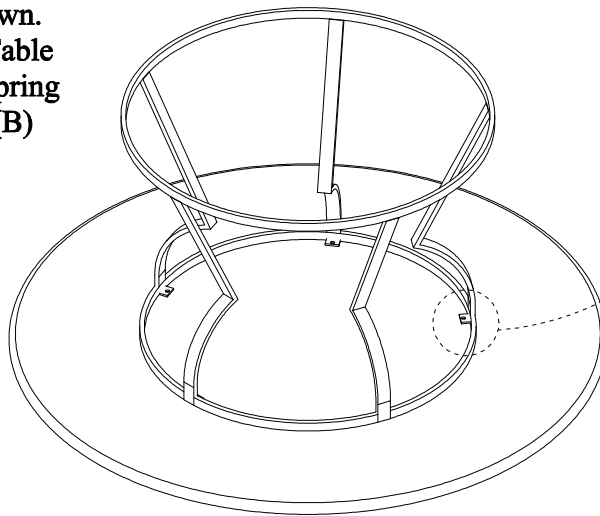

### Step 2: Finished assembly

Turn the Table upright. The Table is now completed and ready for use.

