













Mariah C/E king Assembly Instructions

Hardware Diagram includes factory installed bolts and washers.

A	B	C	D	E	F	F1	G	I	J	K	R	T
												
φ6*15MM	φ8*30MM	φ8*60MM	φ6MM	φ8MM	H=10MM	H=10MM		φ8MM		φ8*80MM	φ8*70MM	φ6*20MM
8PCS	0PC	4PCS	16PCS	10CS	2PCS	2PCS	4PCS	1PC	8PCS	2PCS	4PCS	8PCS

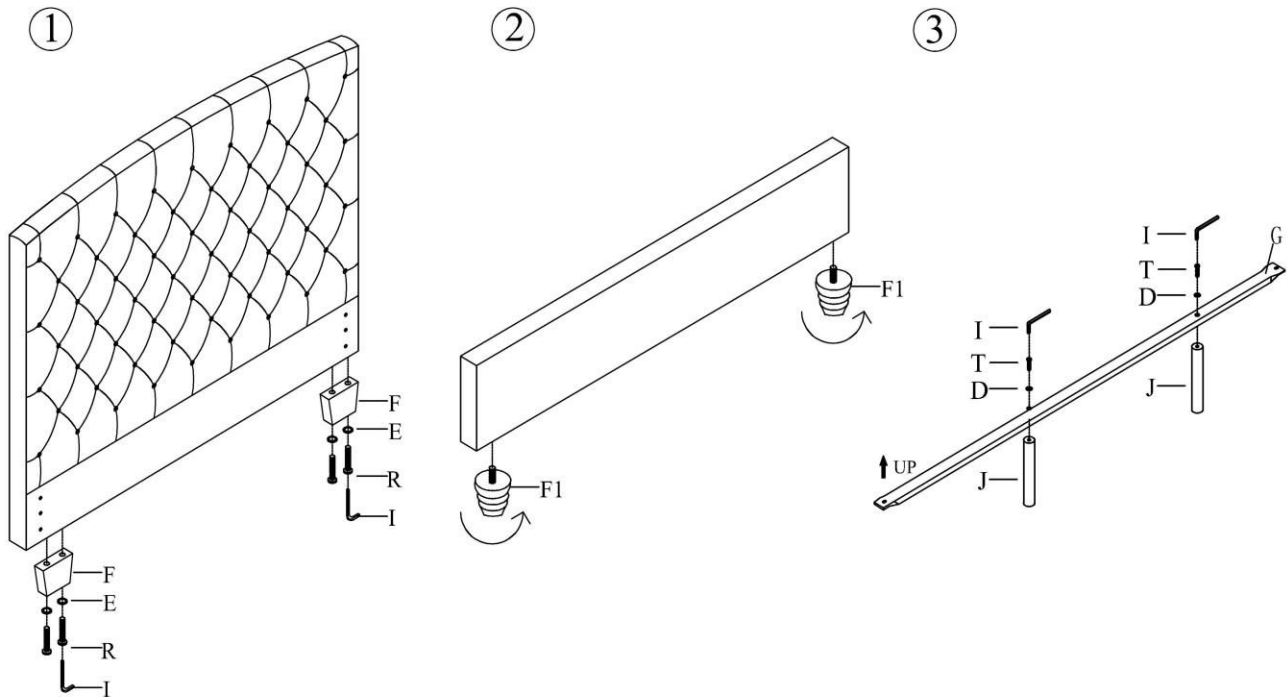

Step#1

Retrieve bed feet from carton fastened behind the headboard. Attach bed feet (F) to the headboard using Wrench (I), Bolt (R) and Washer (E).

Step#2

Attach bed feet (F1) to the footboard.

Step#3

Attach steel center support legs (J) to the Metal slat (G) using Wrench (I), Bolt (T) and Washer (D).













CONGRATULATIONS ON YOUR NEW BED PURCHASE

~Warning: do not move bed after final assembly as it may result in damages to floor and/or bed.~



Mariah C/E king Assembly Instructions

Hardware Diagram includes factory installed bolts and washers.

A	B	C	D	E	F	F1	G	I	J	K	R	T
												
φ6*15MM	φ8*30MM	φ8*60MM	φ6MM	φ8MM	H=10MM	H=10MM		φ8MM		φ8*80MM	φ8*70MM	φ6*20MM
8PCS	0PC	4PCS	16PCS	10CS	2PCS	2PCS	4PCS	1PC	8PCS	2PCS	4PCS	8PCS

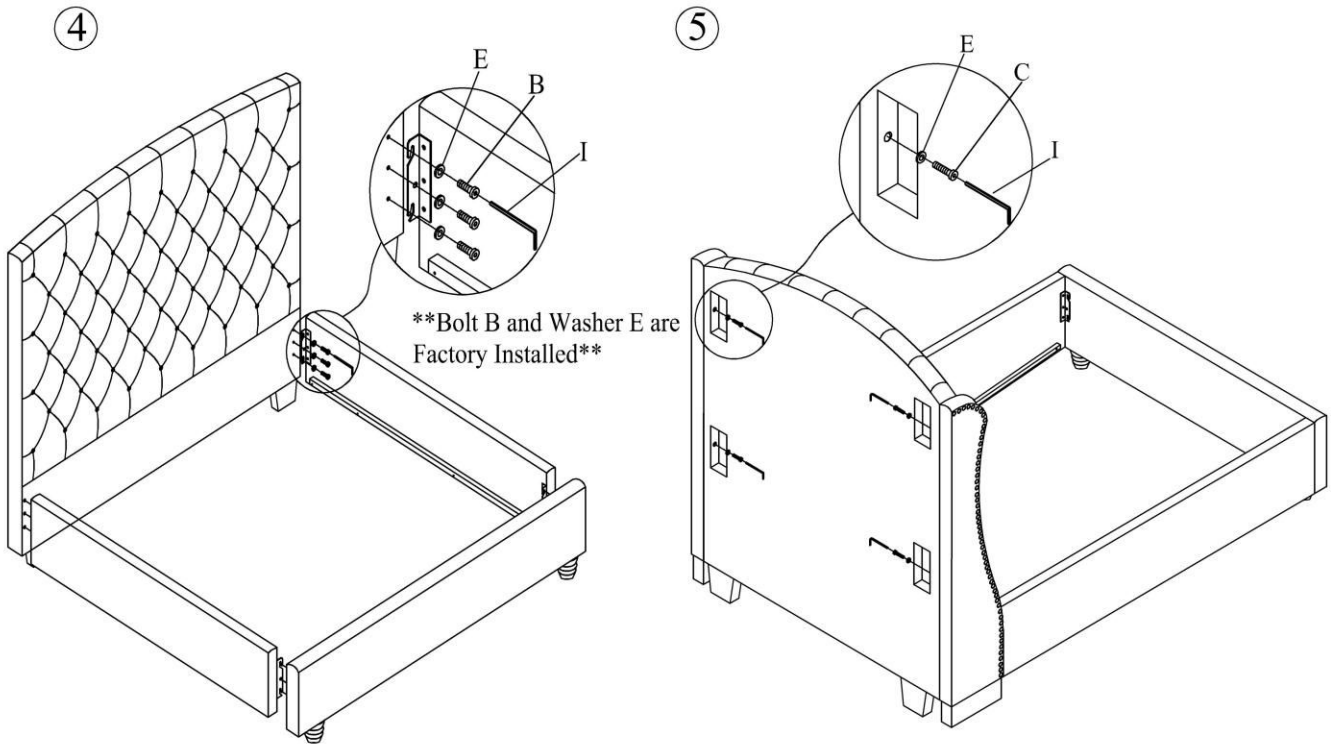

Step#4

Attach side rails to headboard and footboard using Wrench (I), Bolt (B) and Washer (E).

Step#5

Attach wings through HB finger tight, using Wrench (I), Bolt (C) and Washer (E).













CONGRATULATIONS ON YOUR NEW BED PURCHASE

~Warning: do not move bed after final assembly as it may result in damages to floor and/or bed.~



Mariah C/E king Assembly Instructions

Hardware Diagram includes factory installed bolts and washers.

A	B	C	D	E	F	F1	G	I	J	K	R	T
												
φ6*15MM	φ8*30MM	φ8*60MM	φ6MM	φ8MM	H=10MM	H=10MM		φ8MM		φ8*80MM	φ8*70MM	φ6*20MM
8PCS	0PC	4PCS	16PCS	10CS	2PCS	2PCS	4PCS	1PC	8PCS	2PCS	4PCS	8PCS

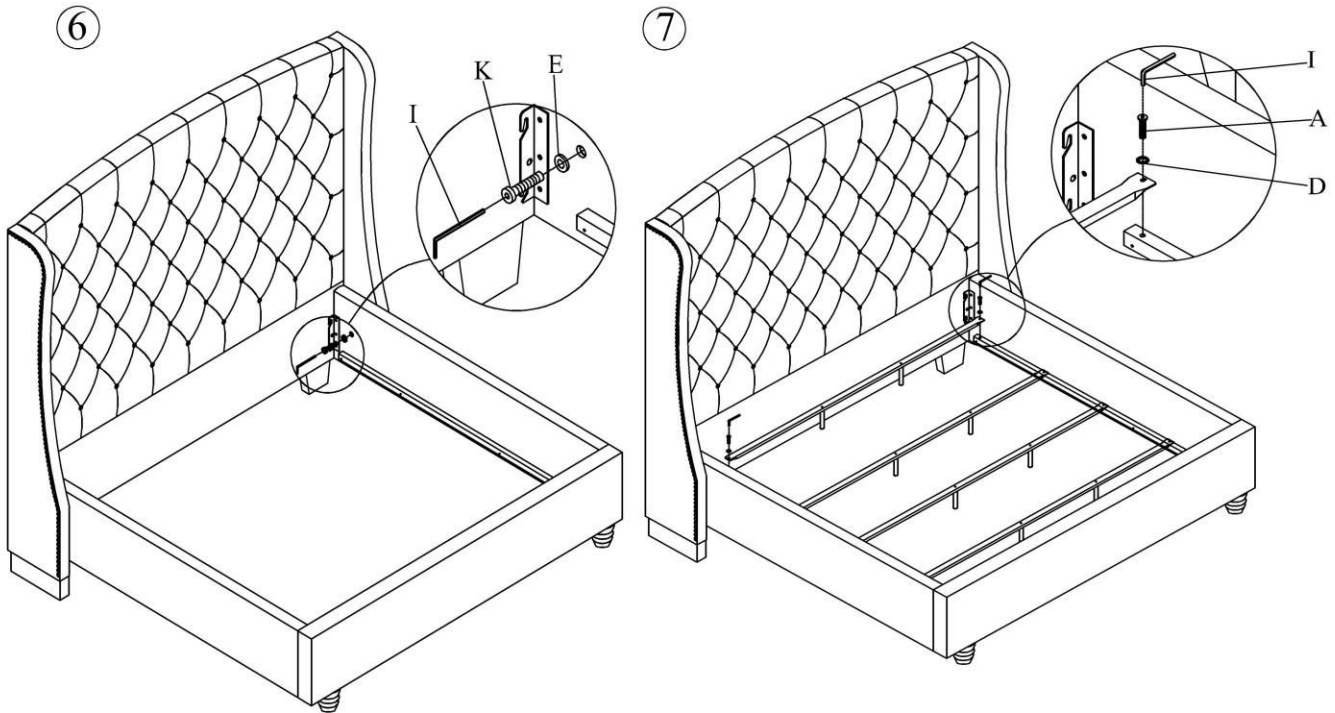

Step#6

Attach wings through side rail finger tight, using Wrench (I), Bolt (K) and Washer (E).
Tighten/secure wings(6 bolts) with Allen Wrench until snug.

Step#7

Move/place bed into final position in bedroom.
Attach steel slat support system to full length steel side rail support cleats (flat side facing up).
Verify the slats are inserted properly into support cleats and center support legs are perpendicular to the floor for full support.

CONGRATULATIONS ON YOUR NEW BED PURCHASE

~Warning: do not move bed after final assembly as it may result in damages to floor and/or bed.~