

Assembly Instructions

3002A 3EL LUCY GREY LAF SOFA

3002A 1ERTC LUCY GREY RAF CHAISE

Before Assembling Products

Please read carefully the instructions prior to assembling the product.

When you have finished assembling the product, please place it on a flat surface and make sure it is stable before use.

- ① When you open the package with a sharp tool like a cutter knife, be careful not to damage the components inside.
- ② Choose a clean, level, spacious assembly area. Avoid hard surfaces that may damage the product.
- ③ Take care when lifting. Please assemble the product in close proximity to where you intend to position the item.
- ④ Ensure that you have all required contents for complete assembly.
- ⑤ Keep all hardware parts and packaging out of reach of small children.
- ⑥ Do not over tighten the screws and bolts as this may damage the threads.

Care and Maintenance

Regular Care

Protect from direct sunlight and direct heat. Vacuum regularly using low suction and soft brush accessory. Avoid heavy soiling caused by perspiration, hair oil, footwear and pets. Always remember that a little love and care for furniture will repay itself many times over.

Cleaning

DO NOT REMOVE ANY PARTS FOR SEPARATE CLEANING. Professional cleaning recommended. Do not use dishwashing or laundry detergents. Use only professional cleaning products. Pay careful attention to armrests, headrests and cushions. Do not wet filling. Dry in shade away from direct heat and sunlight. Allow to dry thoroughly before re-use. ALTERNATIVELY seek professional cleaning only. Upholstery cleaner is most effective for cleaning general soiling, protein or water based stains. Do not scrub upholstery with stiff brushes.

Spot Cleaning

Treat spills and stains as soon as possible. Gently scrape any soil or mop any liquid from the surface of the fabric. Do not scrub. Apply cleaning agents strictly according to instructions.

Always test cleaners on an inconspicuous area before use. Do not saturate the upholstery or the filling with water or other cleaning fluids.



Additional tools
required



Allow 20 minutes



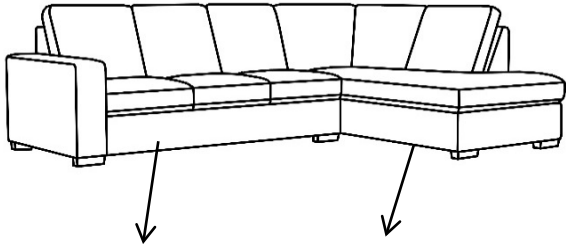

2 people required

Parts List





PART II PART I

Hardware

HARDWARE LIST		
NO.	DESCRIPTION	QTY
A	Inclined Sofa Legs 	4 PCS
B	Support Leg 	1 PCS
C	screw 	13 PCS

PART I

HARDWARE LIST		
NO.	DESCRIPTION	QTY
A	Inclined Sofa Legs 	4 PCS
B	Support Leg 	1 PCS
C	screw 	13 PCS

PART II

Assembling cont.....

PART I

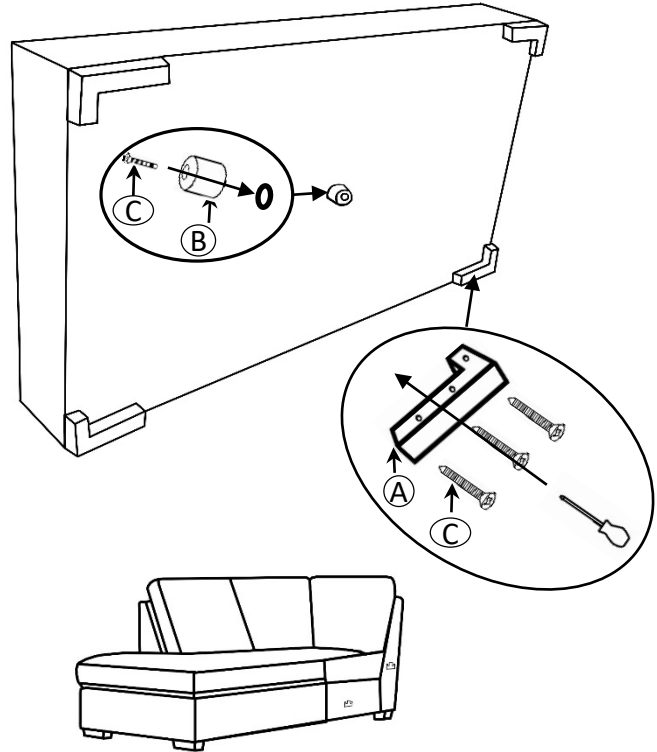

PART II

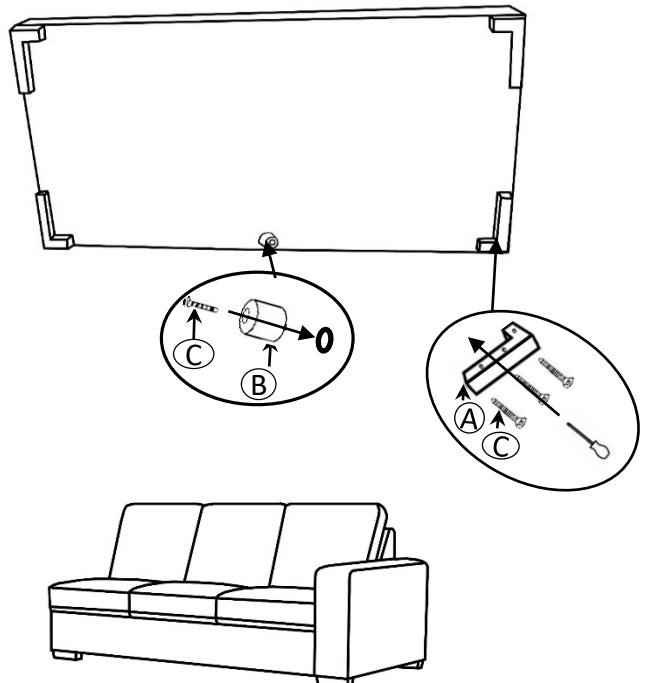

Assembling cont.....

Step 1 – Find the Legs in the box attached outside of the packing

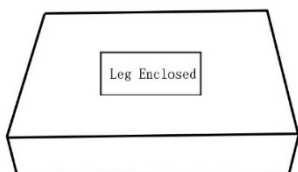

ASSEMBLY COMPLETED

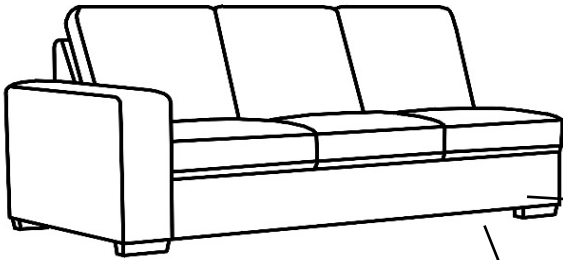

PART II

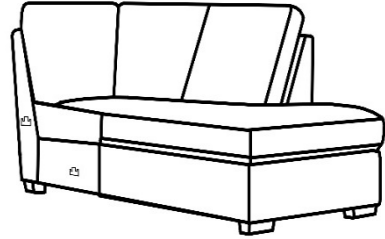

PART I

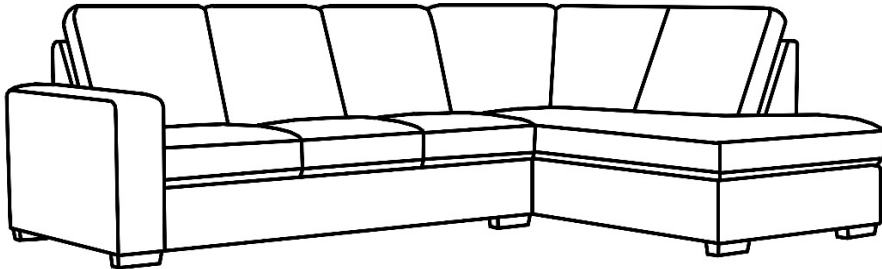
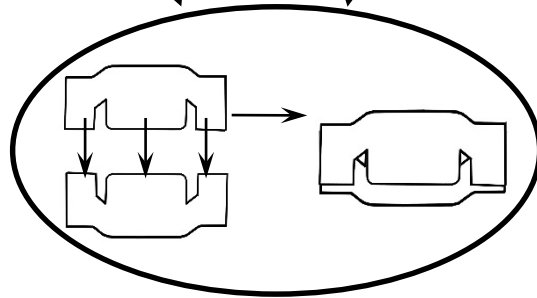

PART II

PART I