



## ASSEMBLY INSTRUCTIONS

ITEM NO: 305-S360-539 / 536 / 411

ITEM NO: SLATR-46

DESCRIPTION: 4/6 METAL ROD STORAGE BED

Thank you for purchasing this quality product. Be sure to check all packing material carefully for small Hardware which may have come loose inside the carton during shipment. Identify and count all Hardware and compare with the Hardware List Below.

305-S360-539 4/6 Metal Rod Headboard

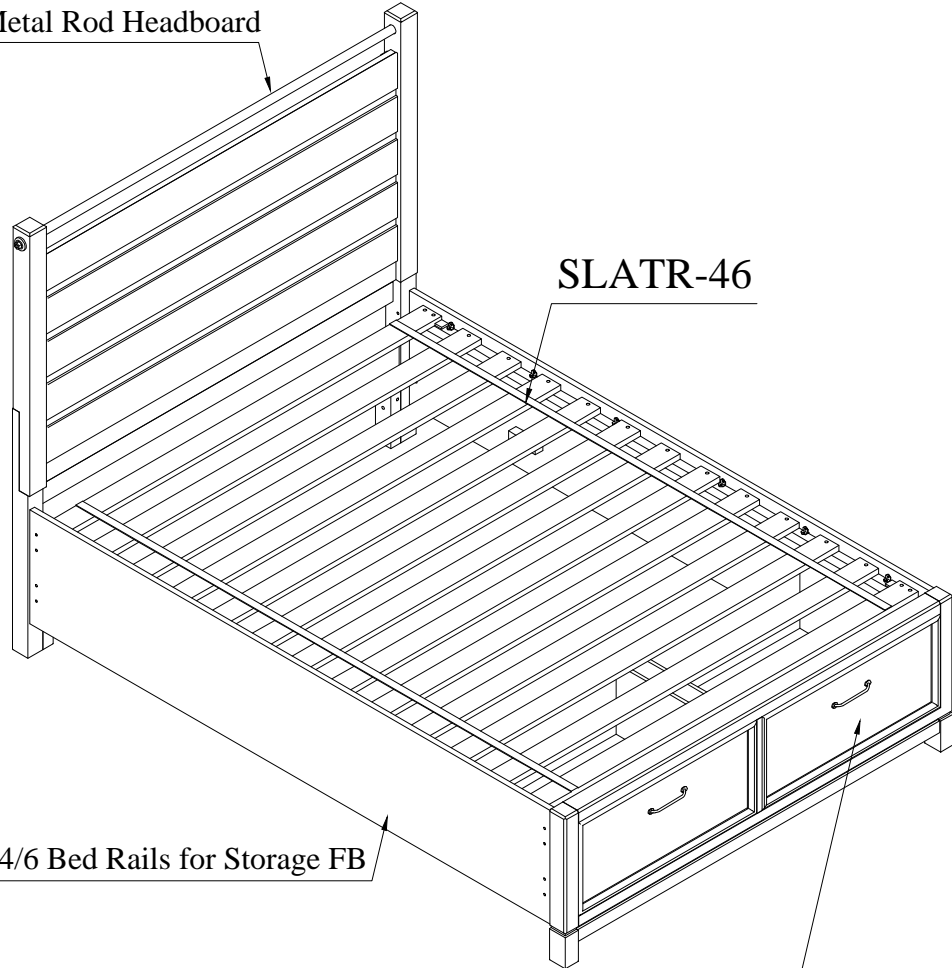

SLATR-46

305-S360-411 3/3-4/6 Bed Rails for Storage FB



305-S360-536 4/6 Storage Footboard

HARDWARE LIST (For SLATR-46)				
No.	Drawing	Descriptions	Size	Qty.
13		Screw	M4 x 32mm	26 PCS

TOOLS REQUIRED (NOT PROVIDED)

 PHILLIPS SCREWDRIVER

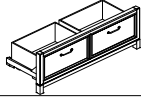
### PART LIST

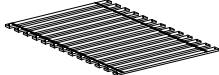
Drawing	Descriptions	Qty.
	4/6 Metal Rod Headboard (305-S360-539 )	1 PC
	4/6 Storage Footboard (305-S360-536)	1 PC
	3/3-4/6 Bed Rails for Storage FB (305-S360-411)	2 PCS
	SLATR-46	1 SET

MADE IN VIET NAM

  
**LIVING SPACES**

**ASSEMBLY INSTRUCTIONS**

ITEM NO: 305-S360-539 / 536 / 411

ITEM NO: SLATR-46

DESCRIPTION: 4/6 METAL ROD STORAGE BED

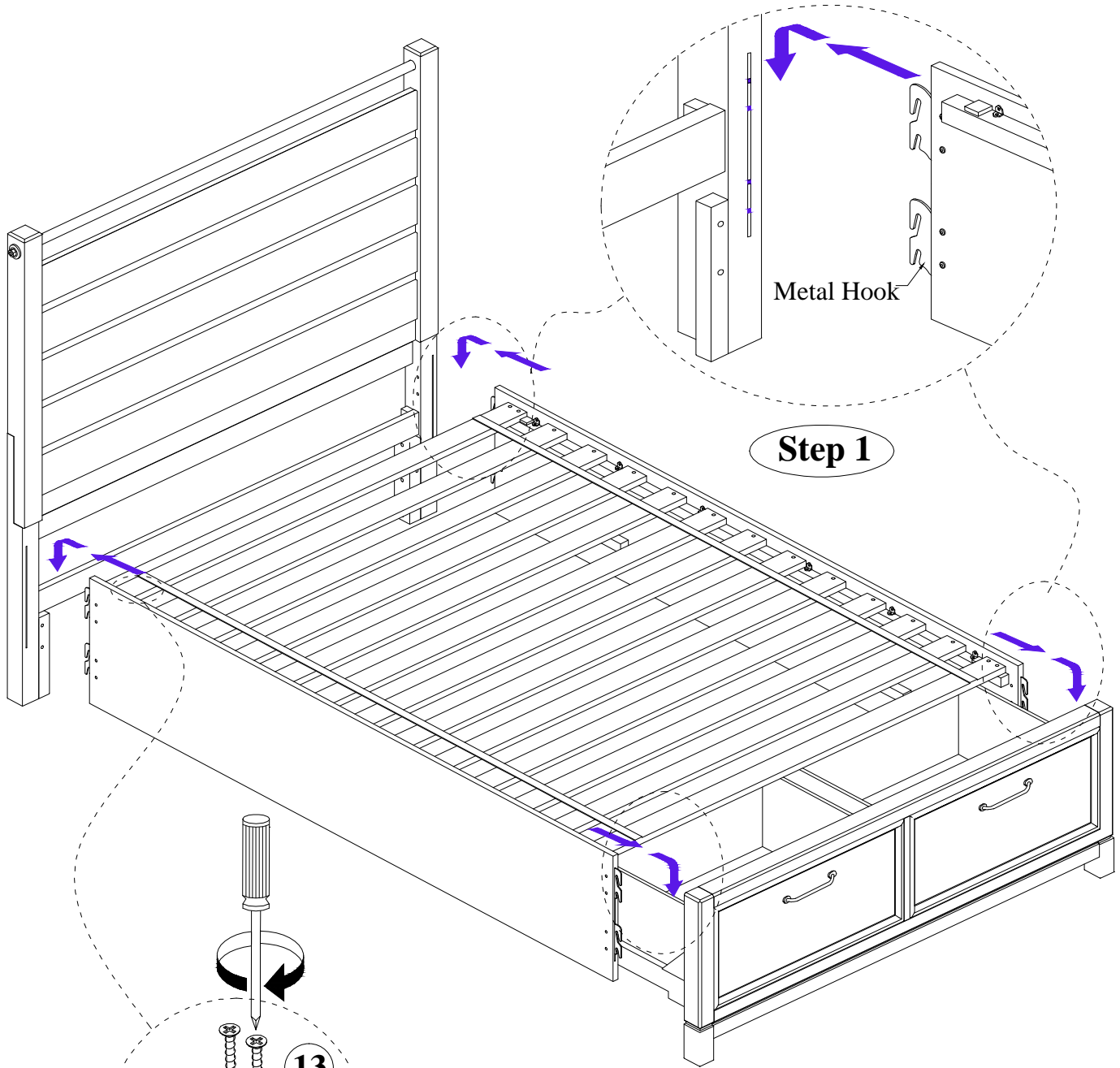

Metal Hook

**Step 1**

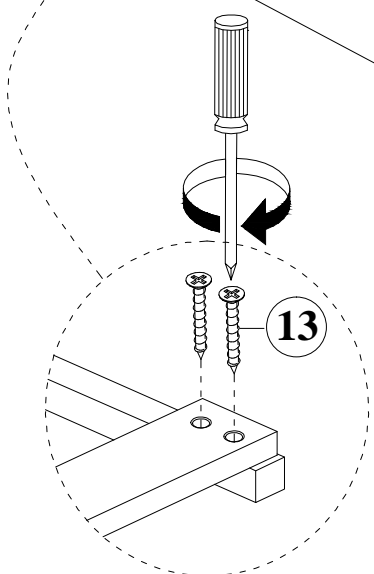

**13**

**Step 2**

The Screw (13) can attach for 1 in 2 holes .

MADE IN VIET NAM