







Gio C/E King Assembly Instructions

Hardware included in side rails carton to attach center support system.

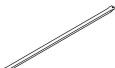
D	F	G	I	J	T	V
						
Φ6 MM	Feet H=2cm	Metal Slats	Φ8 MM	Center support legs H=8CM	Φ6*20MM	Φ6*25MM
16PCS	4PCS	4PCS	1PC	8PCS	8PCS	8PCS

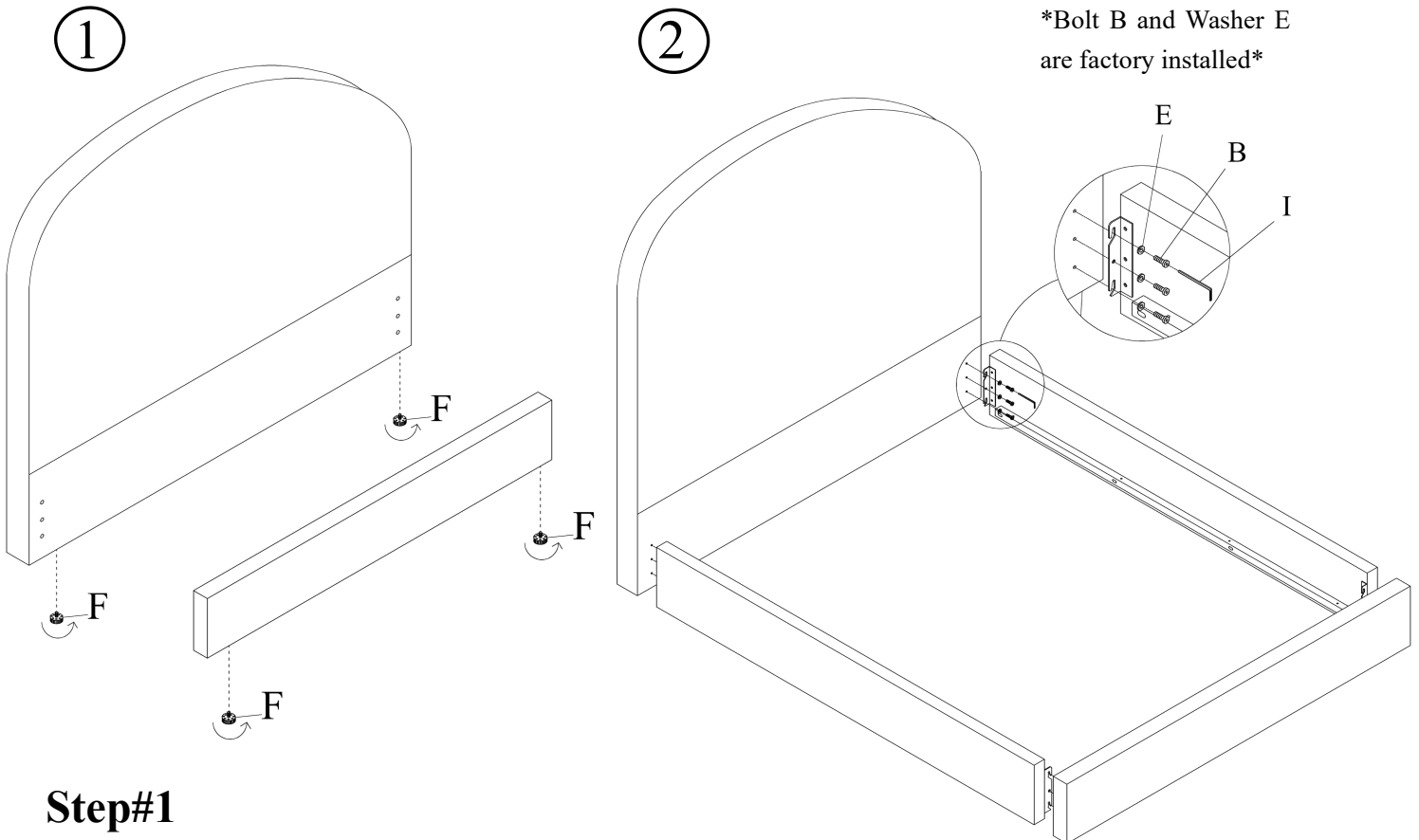

Step#1

Retrieve bed feet from carton fastened behind the headboard.

Attach bed feet (F) to the headboard .

Attach bed feet (F) to the footboard .

Step#2

Attach side rails to headboard using Wrench (I), Bolt (B) and Washer (E)(factory installed).







Attach side rails to footboard using Wrench (I), Bolt (B) and Washer (E)(factory installed).

CONGRATULATIONS ON YOUR NEW BED PURCHASE

~Warning: do not move bed after final assembly as it may result in damages to floor and/or bed.~

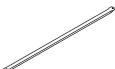
Gio C/E King Assembly Instructions

Hardware included in side rails carton to attach center support system.

D	F	G	I	J	T	V
						
Φ6 MM	Feet H=2cm	Metal Slats	Φ8 MM	Center support legs H=8CM	Φ6*20MM	Φ6*25MM
16PCS	4PCS	4PCS	1PC	8PCS	8PCS	8PCS

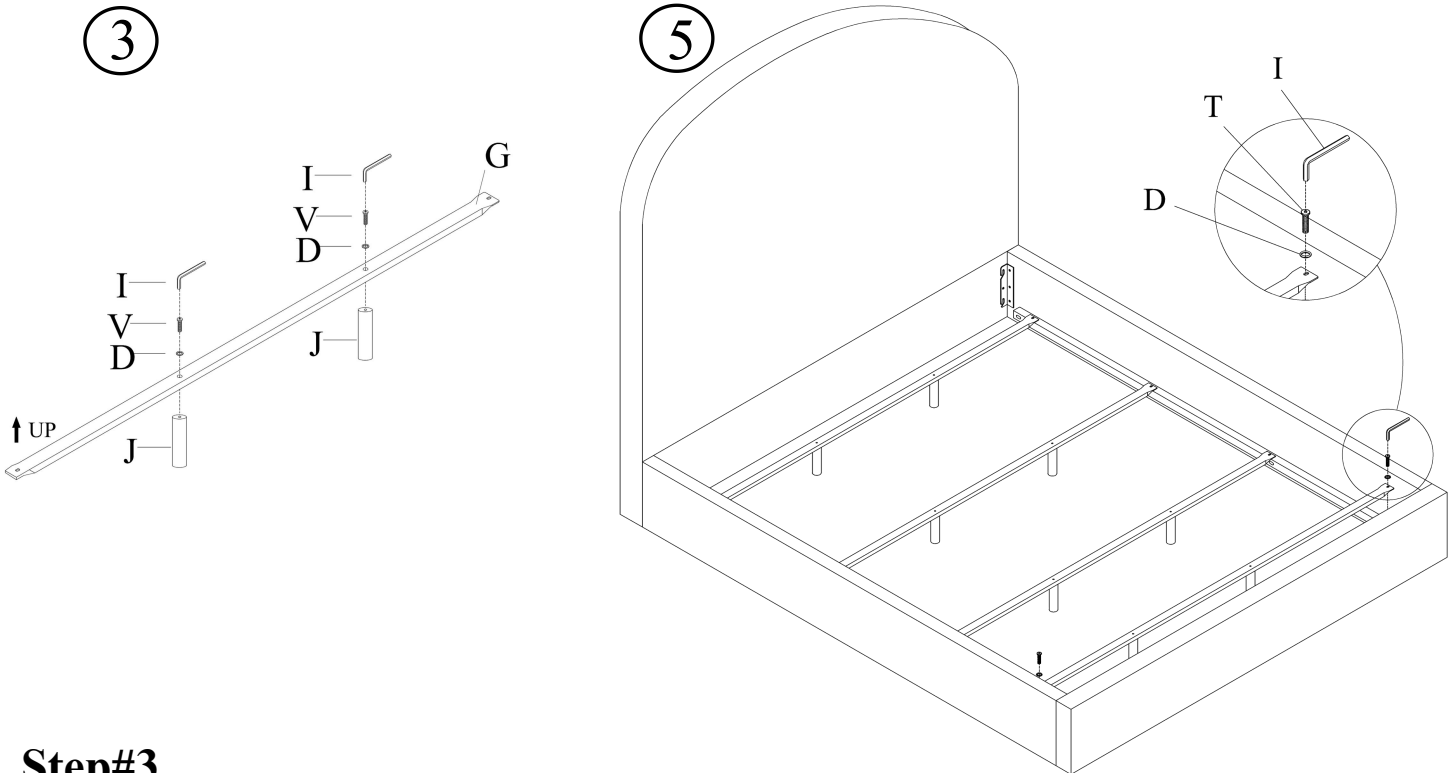

Step#3

Attach steel center support legs (J) to the Metal slat (G) using Wrench (I), Bolt (V) and Washer (D).

Step#4

Move/place bed into final position in bedroom.

Step#5

Attach steel slat support system to full length steel side support cleats (flat side facing up). Verify the metal slats are installed properly into support cleats and center support legs are perpendicular to the floor for full support.

CONGRATULATIONS ON YOUR NEW BED PURCHASE

~Warning: do not move bed after final assembly as it may result in damages to floor and/or bed.~