

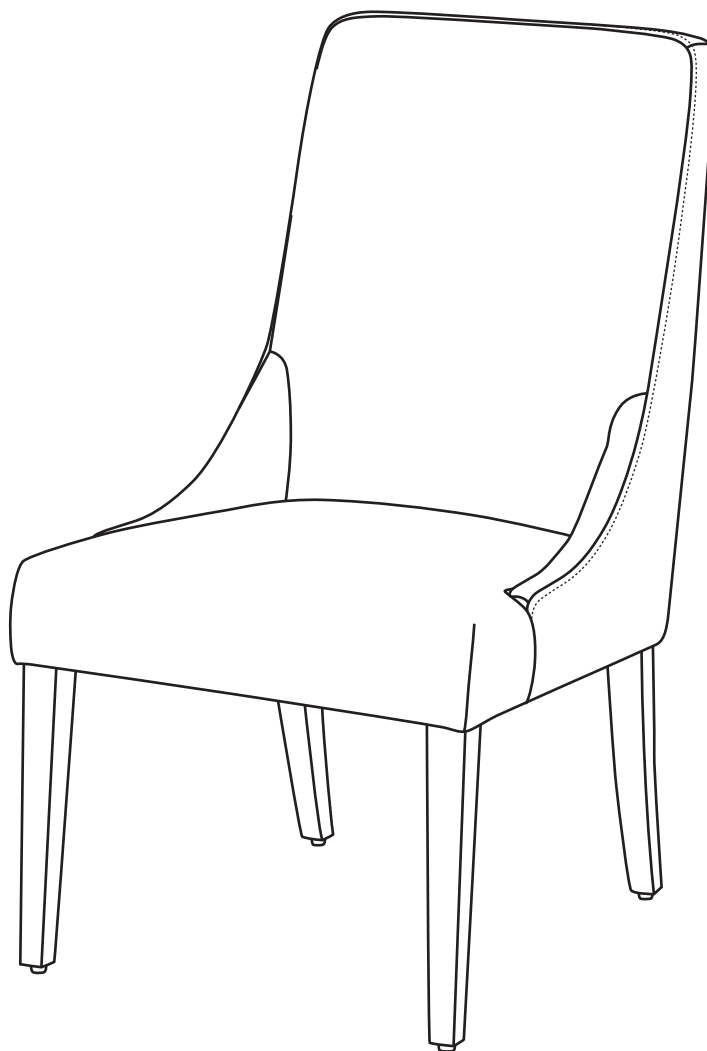

Parker House®
FURNITURE

ASSEMBLY INSTRUCTIONS

Kierra Dining Chair



Description: Kierra Dining Chair

Dimension : 22 1/2"W×29 1/2"D×41"H

Caution: Please inspect all connections periodically and retighten them if loose.

BEFORE ASSEMBLY

Thank you for purchasing this quality product. This product has been designed for easy assembly and constructed for durability. Please take the time to read and follow the assembly instructions carefully.







Be sure to check all packing material carefully for small parts which may have come loose inside the carton during shipment. Please separate, identify, and count all parts and metal hardware. Compare with part list to be sure all parts are present.

IMPORTANT NOTE:

- Unzip cushion seat bottom to remove parts carefully.
- Remove all wrapping material, including staples & packing straps before you start to assemble.
- DO NOT tighten all screws and bolts until completely assembled.
- Keep all hardware parts out of reach of children.

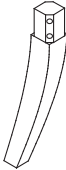
PART LIST

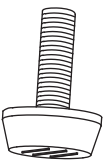
When unpacking, please be careful not to discard any parts with the packaging. Before continuing, please make sure you have the following parts:

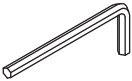
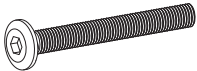
Part	Description	Qty	Drawing	Part	Description	Qty	Drawing
A	Front Leg	2		H2	Spring Washer	8	
B	Back Leg (R)	1		H3	Flat Washer	8	
C	Back Leg (L)	1		H5	Foot leveler	4	
D	Chair Body	1		T1	Allen Wrench	1	
H1	Bolt (M8x60mm)	8					

STEP 1

Please lay the Chair Body (D) on soft, clean surface to assemble.
Open the dust cover and take out the parts package from the bottom of seat.

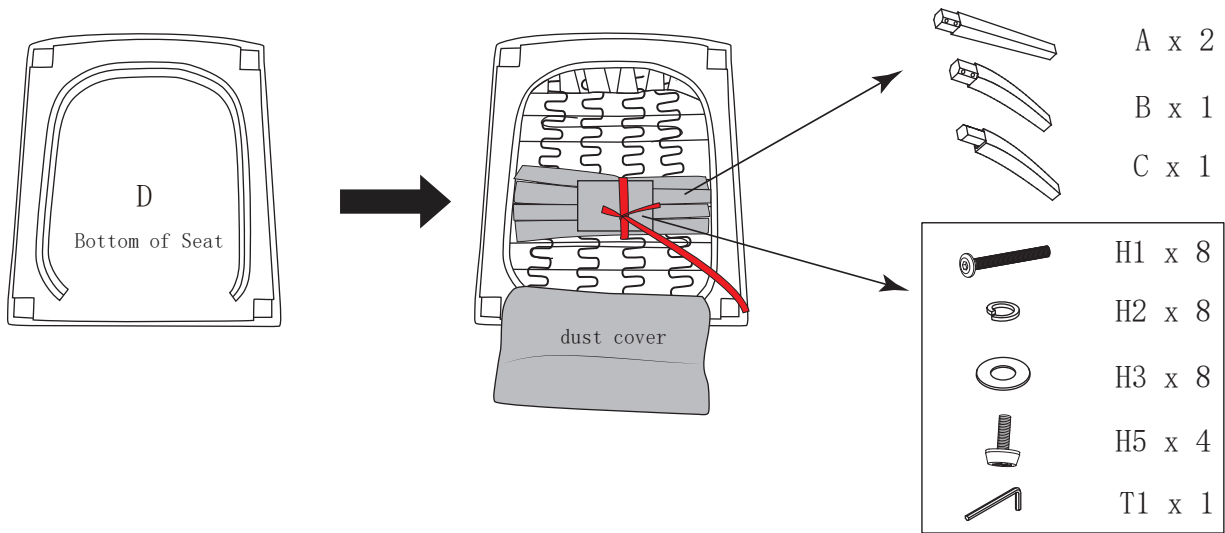

STEP 2

Insert the Front Legs (Ax2) and Back Legs (B&C) into the corresponding four slots on the bottom of the Chair Body (D). Attach them with Bolts (H1x8), Spring Washers (H2x8), Flat Washers (H3x8) and Allen Wrench (T1).

Note: Do not fully tighten yet.

NOTE:

We defined the left and right of wooden legs when facing this product upright.

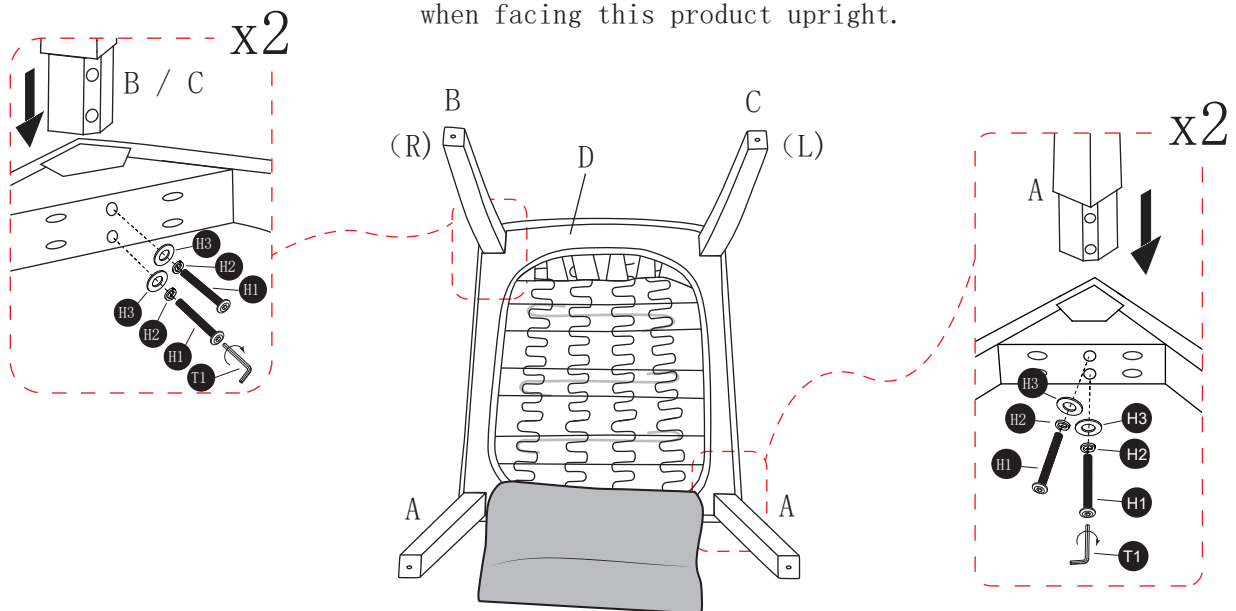

STEP 3

Flip the chair over and press down on seat over legs to secure in place.

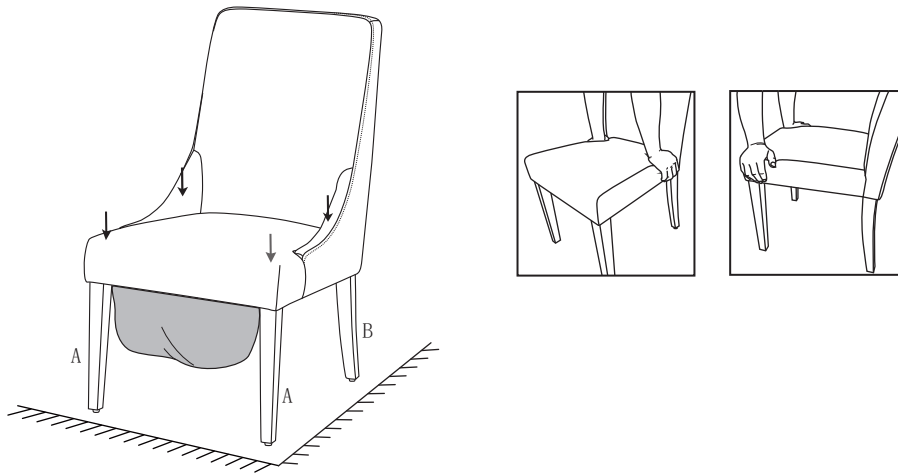

Tighten all bolts and close the dust cover.

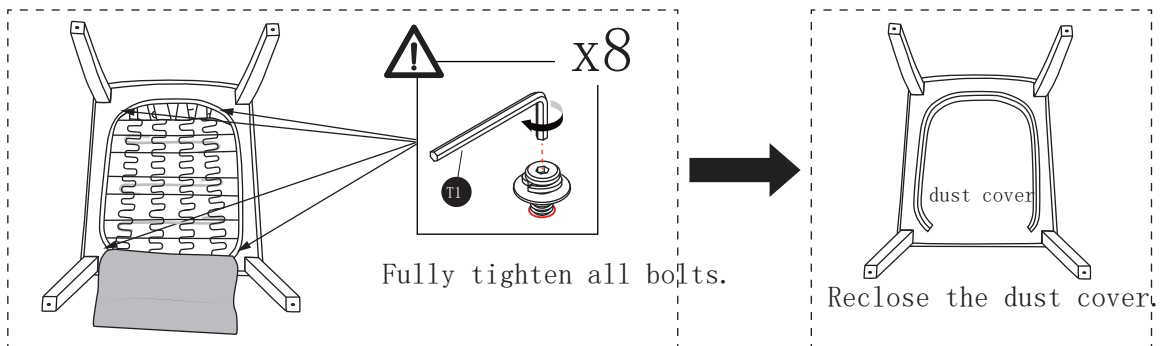

STEP 4

Tighten each Foot Leveler (H5) to each wooden leg.

Adjust the balance of the chair again with foot levelers if needed. Assembly complete.

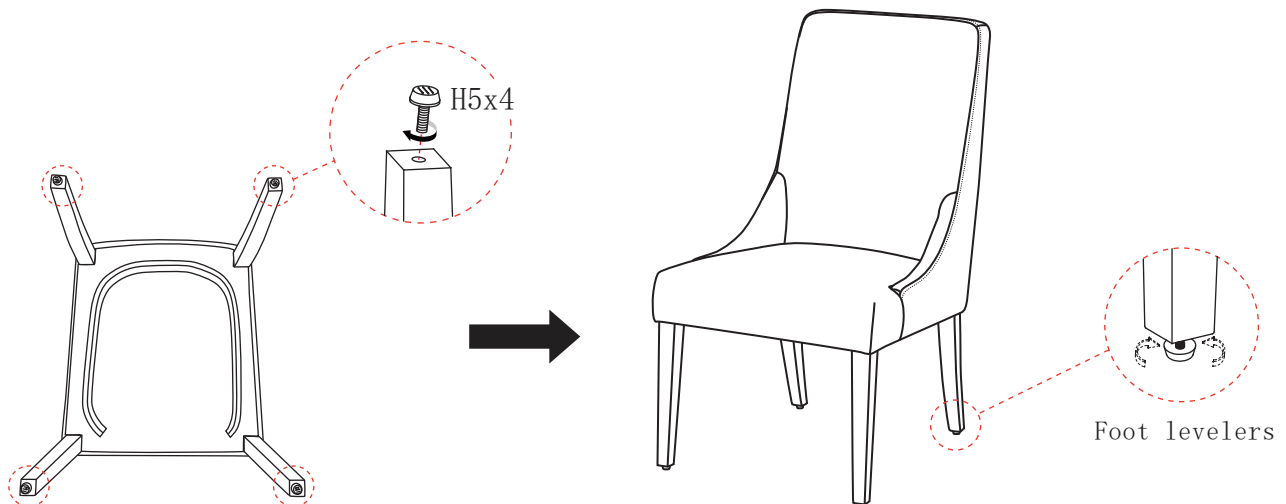

Congratulations! We hope you enjoy your purchase.