











Assembly Instructions

Do not tighten screws until completely assembled
 No apretar los tornillos hasta armar completamente

PARTS LIST/LISTA DE PARTES

NO.	DESCRIPTION	QTY
A	 CHAIR BACK	1PC/PIEZA
B	 LEG(LEFT)	1PC/PIEZA
C	 LEG(RIGHT)	1PC/PIEZA
D	 STRETCHER	1PC/PIEZA

NO.	DESCRIPTION	QTY
E	 M8*25	2PCS/PIEZA
F	 M6*50	4PCS/PIEZA
G	 #5	1PC/PIEZA
H	 M8*16	2PCS/PIEZA
K	 M6*16	4PCS/PIEZA
L	 M6	4PCS/PIEZA
M	 M8	2PCS/PIEZA

STEP 1 PASO 1

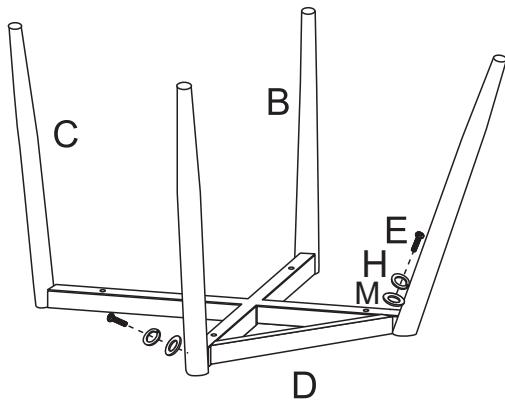

STEP 2 PASO 2

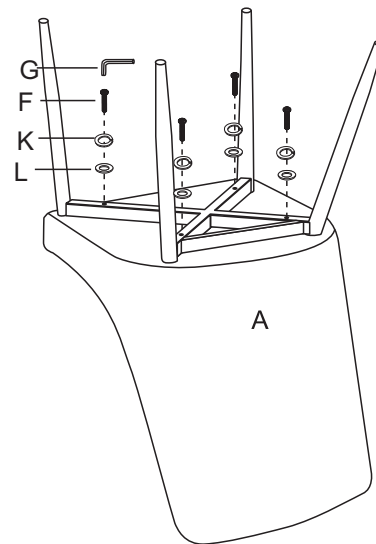

STEP 3 PASO 3

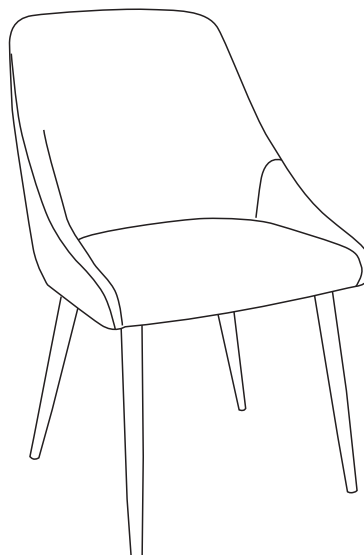



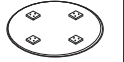
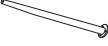

Assembly Instructions

Do not tighten screws until completely assembled
 No apretar los tornillos hasta armar completamente

PARTS LIST/LISTA DE PARTES

NO.	DESCRIPTION	QTY
A	TABLE TOP 	1PC/PIEZA
B	TABLE LEGS 	4PCS/PIEZA

NO.	DESCRIPTION	QTY
C	Bolt 	12PCS/PIEZA
D	Spring Washer 	12PCS/PIEZA
E	Flat washer 	12PCS/PIEZA
F	Allen Wrench 	1PC/PIEZA

STEP 1 PASO 1

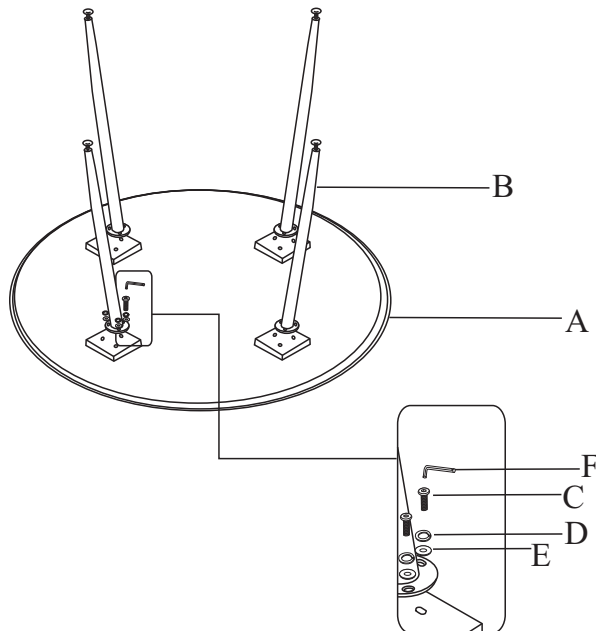

STEP 2 PASO 2

