



LIVING SPACES

Vendor Information

Vendor Name: LSMX1
Vendor Code: V-005852



Living Space Information

LS SKU: 327995
LS product Name: KENAI PEARL ARMLESS CHAIR
Vendor Model #: 1963-ARMC-KE-PEA
Vendor Collection:KENAI

CODE	PART #	DESCRIPTION	SHIPS IN 48 HRS	QUANTITY	PRICING	NOTES
A	LEGMETKE	METAL LEG KENAI CHAIR BLK	YES	4		
B	SCW14114	1/4-20X1-1/4 SOCKET HEAD	YES	12		
C	ALLEN532	KEY ALLEN 5/32	YES	1		
D	SCREW112	6 x 1 1/2 PHIL BUGLE D/W BACK	YES	8		

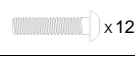
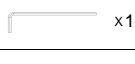
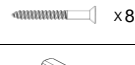

LIVING SPACES

A	LEGMETKE	 x4
B	SCW14114	 x12
C	ALLEN532	 x1
	SCREW112	 x8
1	ARMLESS KENAI	 x1

STEP 1: PLACE LEGS

ARMLESS KENAI

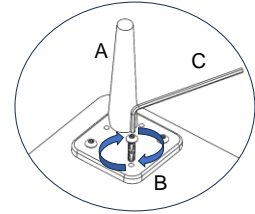
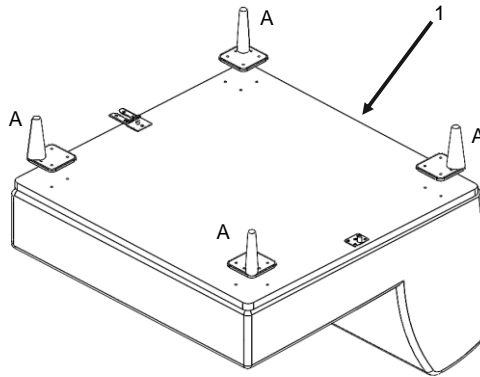

USE THE ALLEN WRENCH TO SCREW

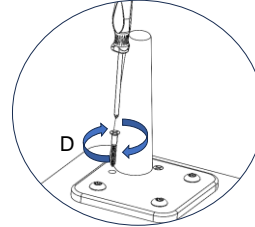

USE A SCREWDRIVER TO ATTACH THE LEGS

ARMLESS KENAI

