



ASSEMBLY INSTRUCTIONS





ITEM 305-P381400

CHAPLEAU DINING BENCH





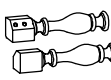

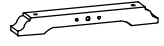

Thank you for purchasing this quality product. Be sure to check all packing material carefully for small hardware which may have come loose inside the carton during shipment. Identify and count all hardware and compare with the hardware list below.

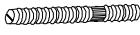
When placing furniture on non-carpeted flooring, HMI recommends the use of floor protection such as an area rug or furniture pads. Area rugs and padding not included with purchase.

PARTS LIST

No.	Description	Sketch	Q.ty
1	Bench Top		1
2	Stretcher		2
3	Center Leg		2
4	Leg (Left & Right)		4
5	Base Leg		2
6	Center Base Leg		1

HARDWARE LIST

No.	Description	Sketch	Size	Q.ty
A	Hanger Bolt		Ø5/16" x 3-1/2"	4
B	Collar Hex Nut		Ø5/16"	4
C	Flat washer		Ø5/16" x 28 x 14	4
D	Wrench		12 mm	1
E	Allen Bolt		Ø5/16 " x 2-3/4"	6
F	Lock washer		Ø5/16 "	18
G	Flat washer		Ø5/16 " x 3/4 "	18
H	Allen Key		M4	1
K	Allen Bolt		Ø5/16 " x 2-1/4"	12

STEP 1

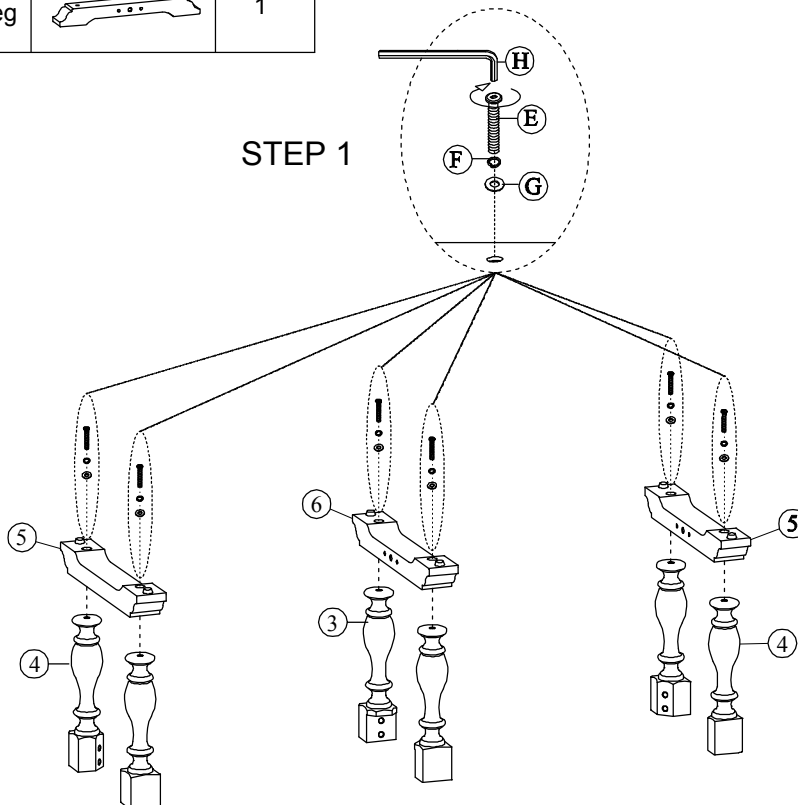



LIVING SPACES



ASSEMBLY INSTRUCTIONS

ITEM 305-P381400

CHAPLEAU DINING BENCH

STEP 2

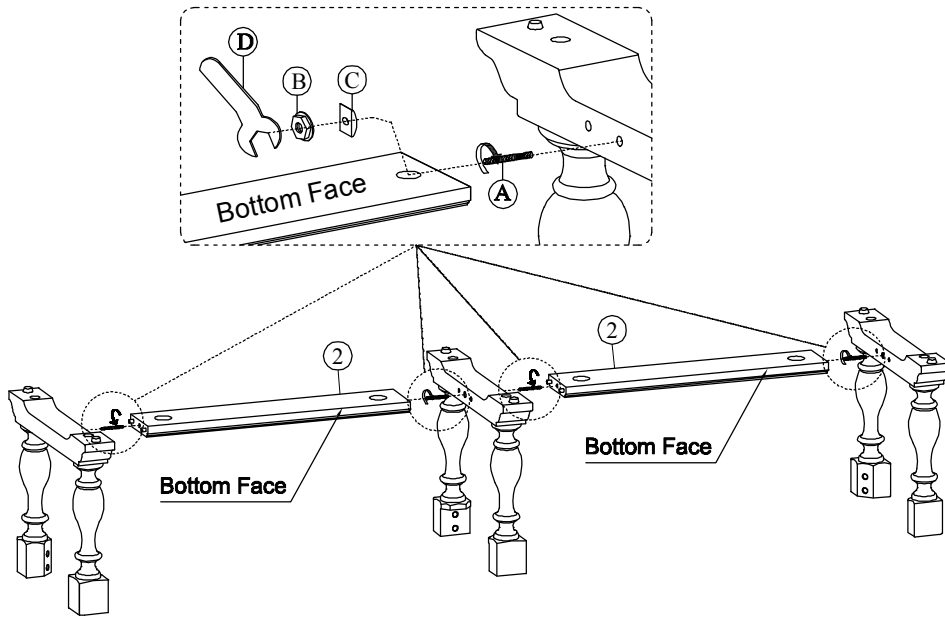

STEP 3

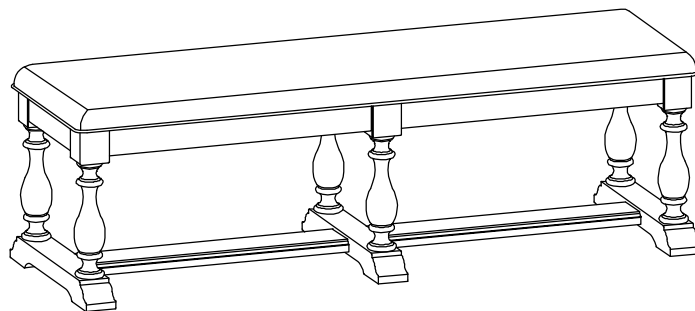
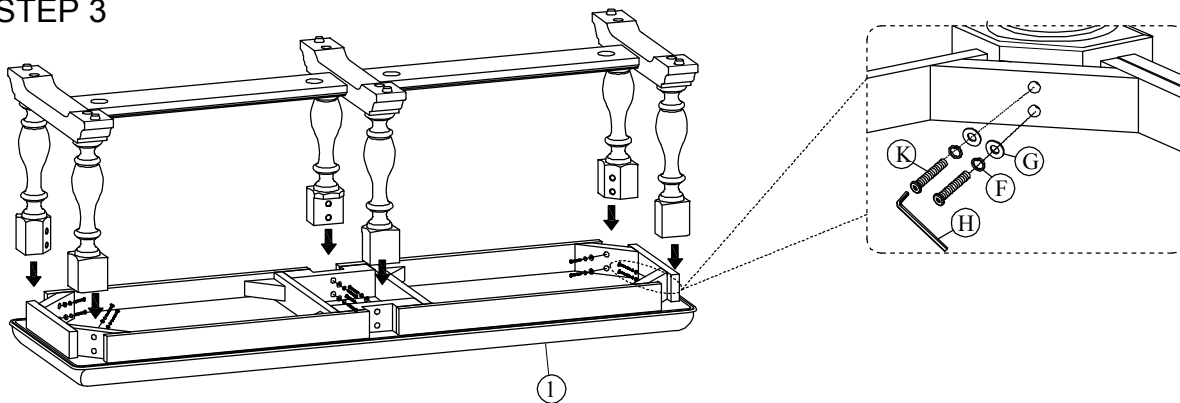

COMPLETE ASSEMBLY



LIVING SPACES



REPLACEMENT PARTS

ITEM 305-P381400

CHAPLEAU DINING BENCH

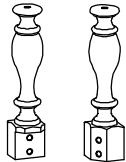

x4 RP381400-LEGS
Side Leg

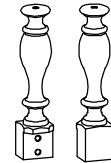

x2 RP381400-LEGM
Middle Leg

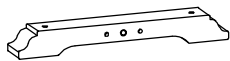

x2 RP381400-BASES
Side Base Leg

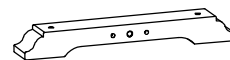

x1 RP381400-BASEM
Middle Base Leg

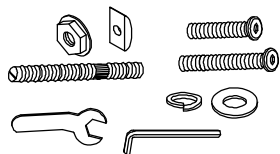

x1 RP381400-HWKIT
Hardware Kit



x2 RP381400-STRET
Bench Stretcher



x4 RC-WH-BROWN
Brown Plastic Nail