



MAGNUSSEN[®]
HOME

ASSEMBLY INSTRUCTIONS
INSTRUCTIONS DE MONTAGE
INSTRUCCIONES DE MONTAJE

MODEL/ MODÈLE/ MODELO: B5487-57H+54F+54R QUEEN LIGHTED BED
B5665-57H+54F+54R QUEEN LIGHTED BED

Note:

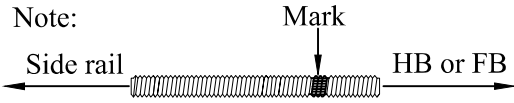

OPTION-3

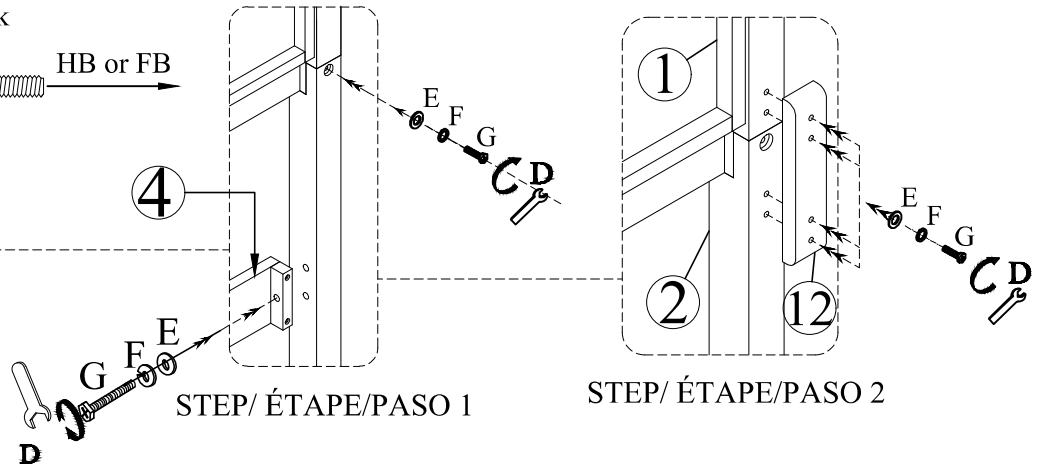

STEP/ ÉTAPE/ PASO 3

Step/ Étape/ Paso 4

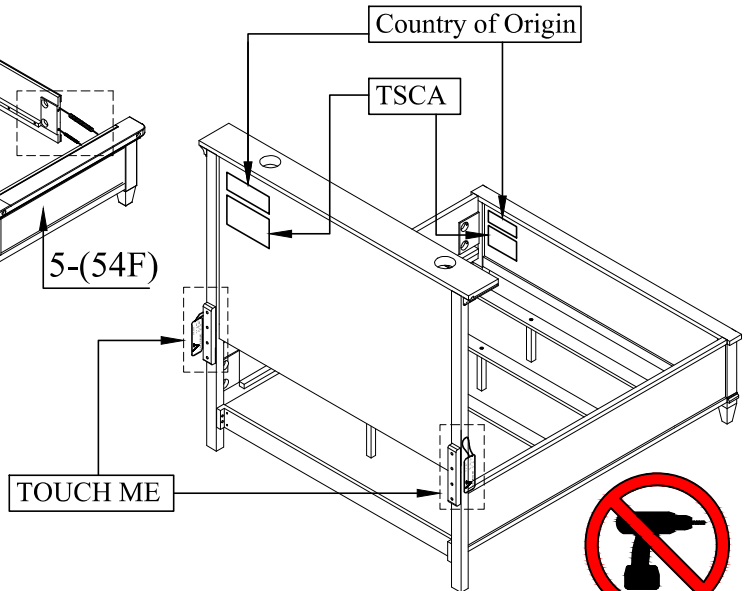
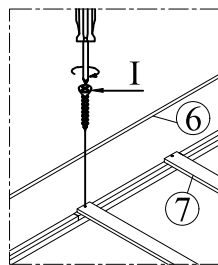
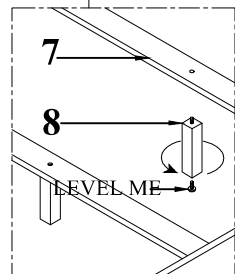
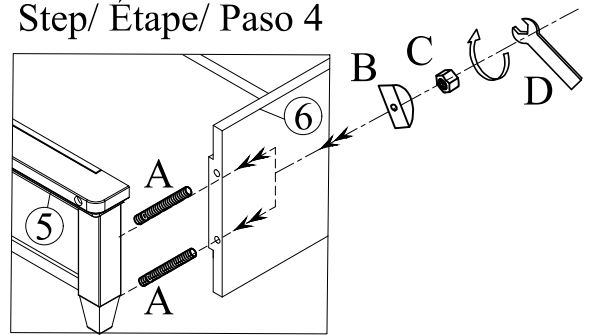
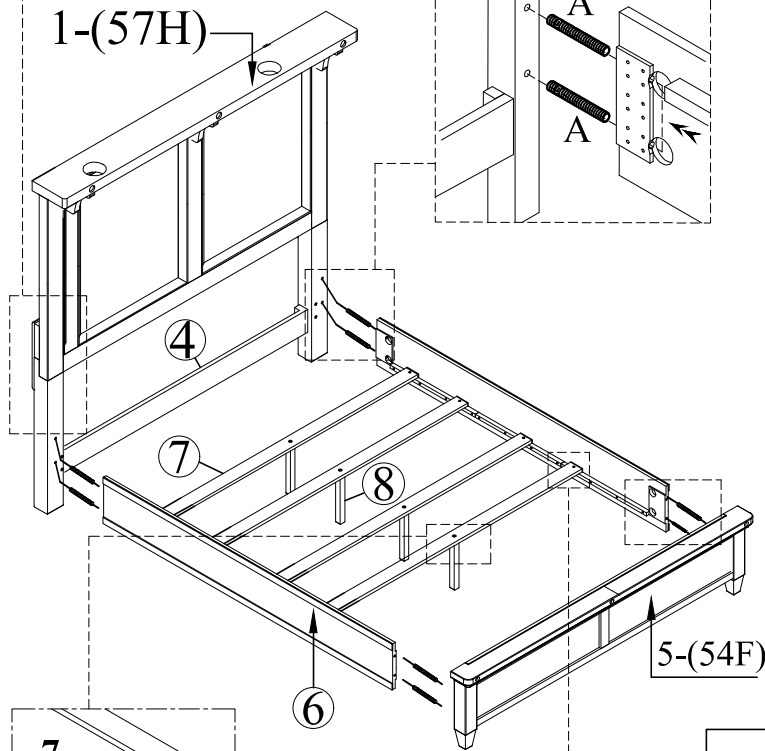

WARNING:
ONLY USE THE HAND
TOOLS PROVIDED