

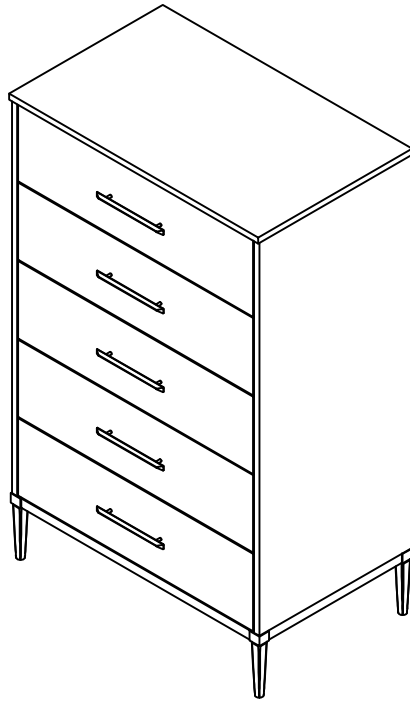

LIVING SPACES





CAMILA II CHEST OF DRAWERS

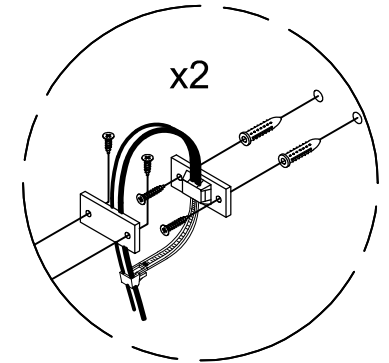
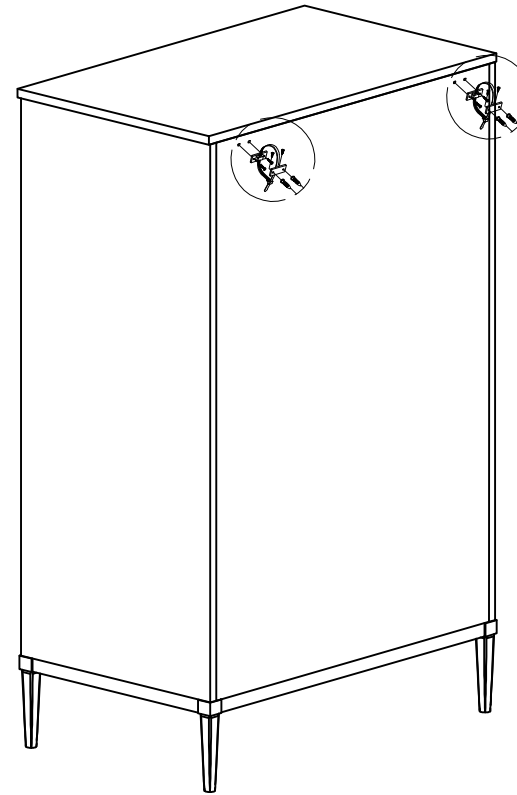
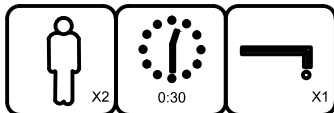

1903-10CH-ASTM / 325880
CAMILA II CHEST OF DRAWERS



Anti-tip kit Hardware Illustration

x 4  Screw Ø4 x 15m/mL	x 4  Screw Ø4 x 35m/mL	x 4  Plastic wall screw	x 4  Bracket	x 2  Strap
--	--	--	---	---