

ITEM: 753498

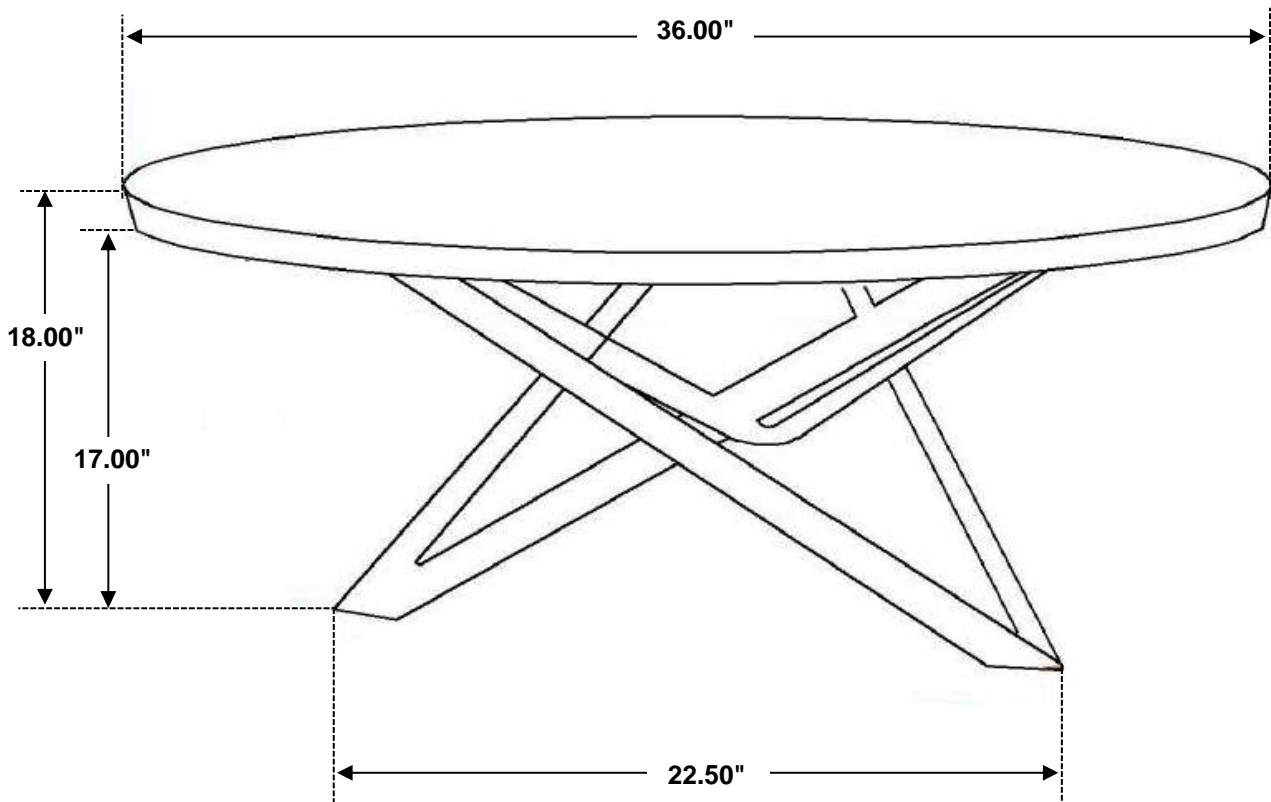

Note: Dimension tolerance $\pm 5\%$