





LIVING SPACES

ASSEMBLY INSTRUCTIONS



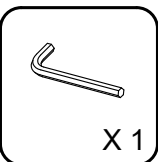
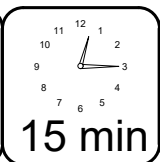
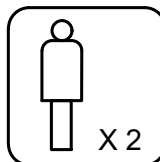
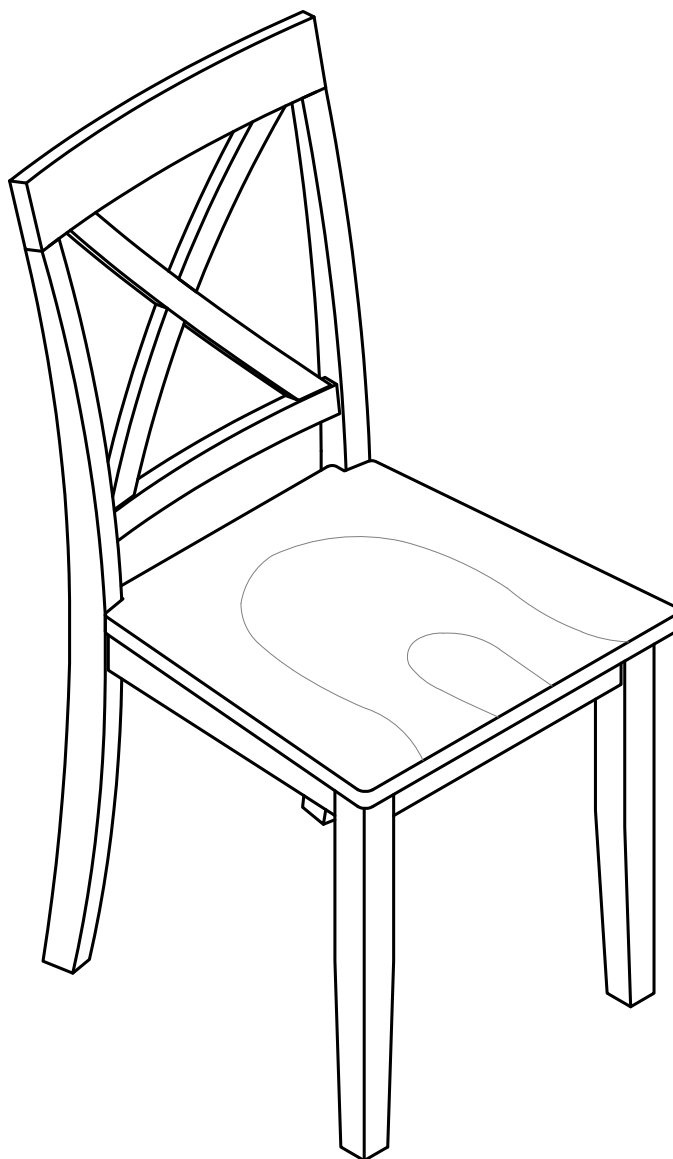

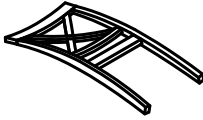

LEELA X-BACK SIDE CHAIR

ITEM: D2109-227 SKU:323809



PART	SKU#	IMAGE	DESCRIPTION	QTY
Ⓐ	323813-A		CHAIR BACK	2
Ⓑ	323813-B		SEAT FRAME	2
Ⓒ	323813-C		LEGS	4

Hardware list of *ORTA DINING SIDE CHAIR - for 2 chair*

PART	SKU#	IMAGE	DESCRIPTION	QTY
①	323813-4(1)		Allen key 60x22x4mm	1
②	323813-2(9)		Spring washer Ø5/16"x13	20
③	323813-3(9)		Flat washer Ø5/16"x19	20
④	323813-1(1)		Short Bolt 1/4"x38mm	4
⑤	323813-1(4)		Medium Bolt 1/4"x60mm	8
⑥	323813-1(4)		Long Bolt 1/4"x75mm	8

Note: Screwdriver will be prepared by yourself.

THE HARD WARE IS LOCATED IN THE PACKING ITEM

NOTE: MUST TIGHTEN SCREWS PERIODIACLLY. WITH USE SCREW MAY ENCOME LOOSE CHECK TIGHTNESS OF ALL SCREWS EVERY 6-8 WEEKS.

CLEANING INSTRUCTIONS:

After assembly, clean and polish the completed parts if necessary with soft cloth and industrial recognized furniture polish.

DETAIL VIEW

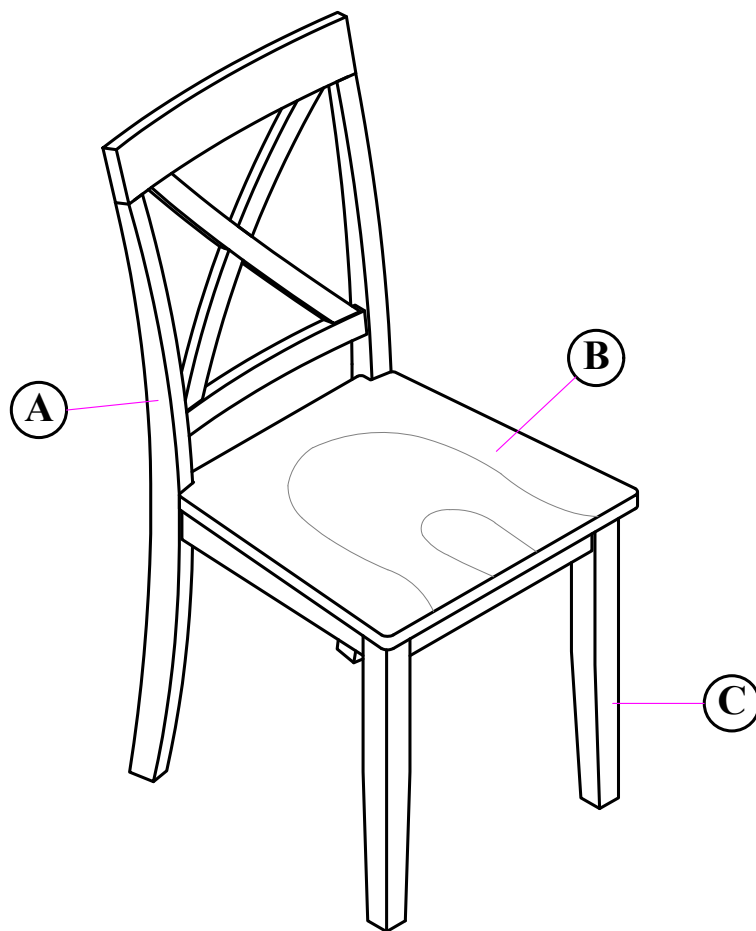

STEP 1: Place the Chair Back (A) on a piece of cloth or carpet to prevent finish from scratching.

* Attach Seat Frame (B) to Chair Back (A) by securing the Flat Washer (3), Lock Washer (2), Short Bolt (4) on back rail and Long Bolt (6) onto Corner with Allen Key (1).

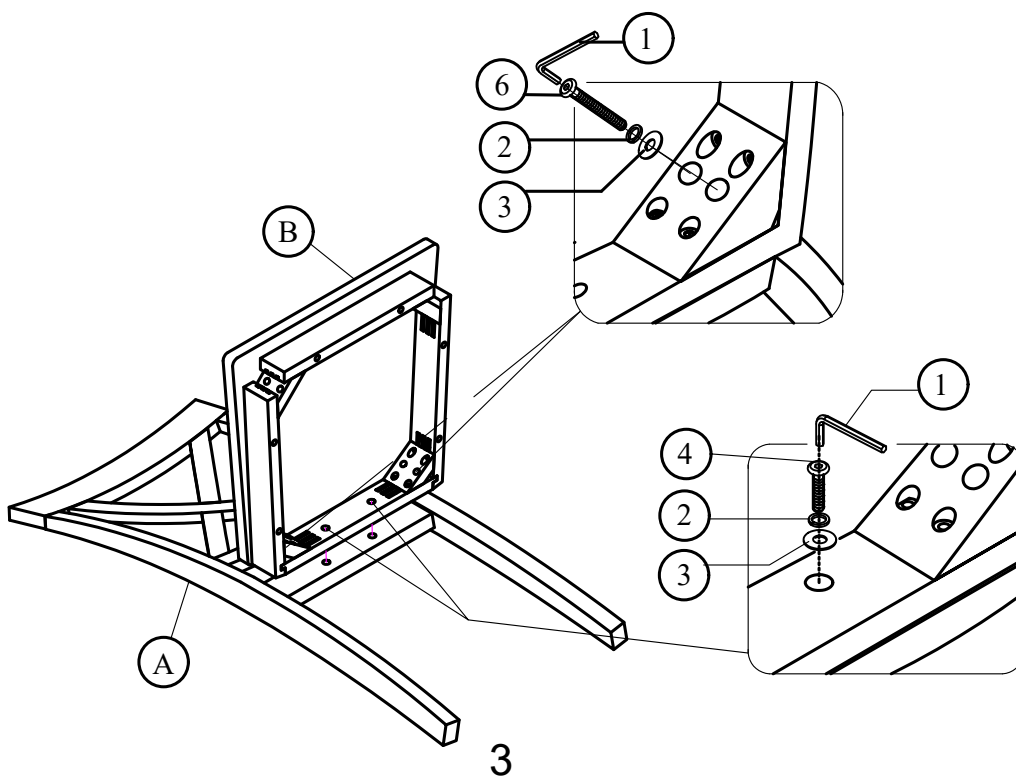

STEP 2:

* Attach the Left and Right Front Leg (C) to Seat Frame (B) by using Flat Washer (3), Lock Washer (2), Medium Bolt (5) and tighten with Allen Key (1).

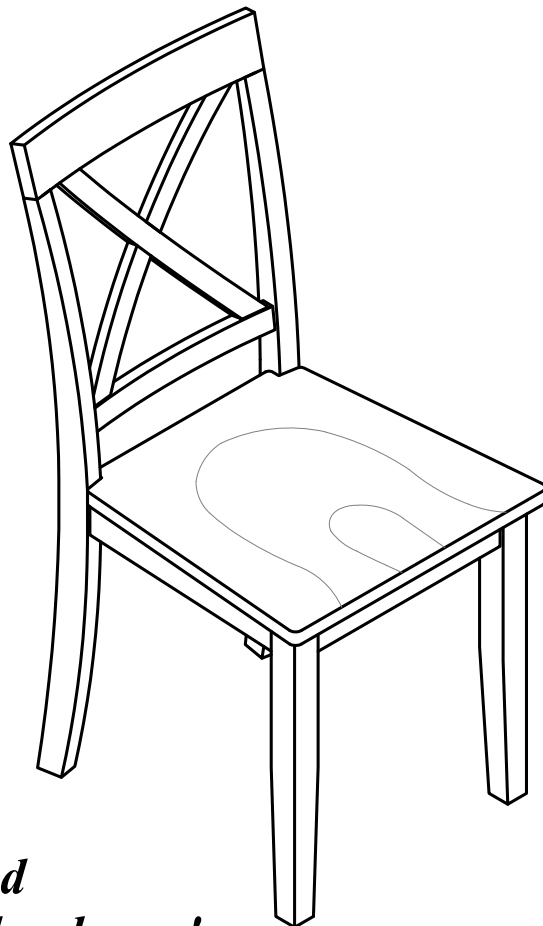
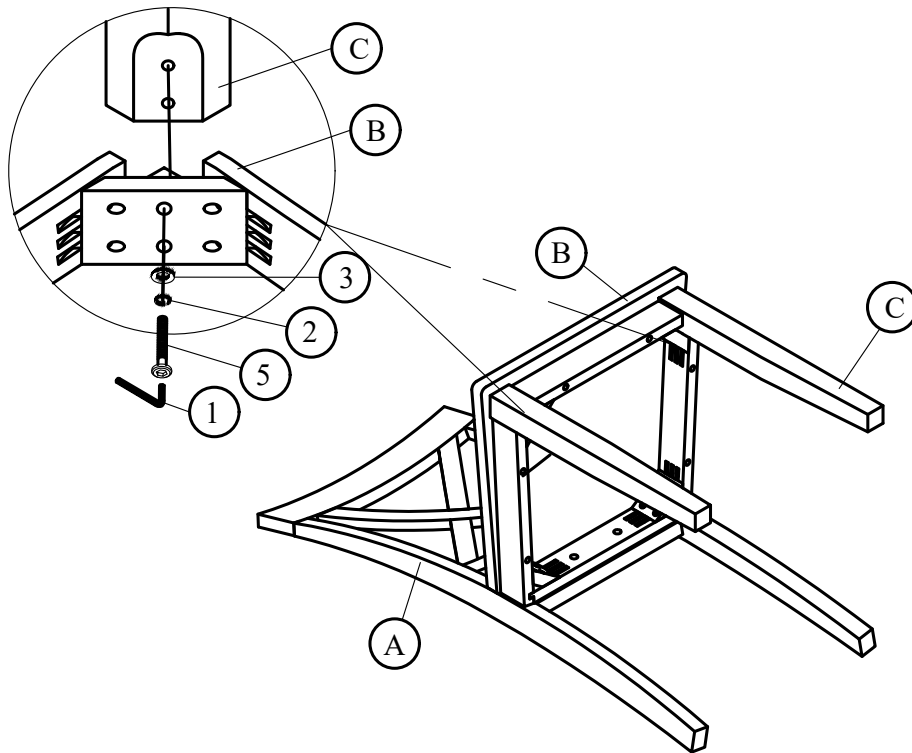

***That's it ! You've finished
assembling your item. Thank you!***