







Headboard hardware located in velcro pouch in back of headboard.
Footboard hardware located in one end of the footboard/siderails.

LOCKWOOD

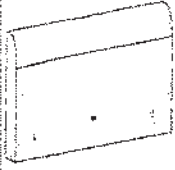



KING/QUEEN UPHOLSTERED PANEL BED
SKU: 322739, 322742

Thank you for purchasing this quality product. Be sure to check all packing material carefully for small parts that may have come loose inside the carton during shipment.







PARTS LIST:

NO.	Description	Sketch	Quantity
A	Headboard		1PC
B	Footboard		1PC
C	Side Rail		2PCS
D	Center Rail		1PC
E	Center Rail Support Leg		3PCS
F	Slats		1Set
G	Leg		2PCS

HB HARDWARE LIST:

NO.	Description	Sketch	Size	Quantity
H	Flat Washer		Ø5/16"	8PCS
I	Spring Washer		Ø5/16"	8PCS
J	Bolt		Ø5/16"x2-1/2"	4PCS
K	Nut		M12	4PCS
L	Spanner		M12	1PC

FB HARDWARE LIST:

NO.	Description	Sketch	Size	Quantity
H	Flat Washer		Ø5/16"	9PCS
I	Spring Washer		Ø5/16"	9PCS
J	Bolt		Ø5/16"x2-1/2"	2PCS
M	Bolt		Ø5/16"x1-1/2"	7PCS
N	Screw		Ø8x1-1/2"	26PCS
O	Screw		Ø8x3/4"	4PCS
P	Allen Key		M5x4"	1PC
Q	Metal bracket		50x32x30	2PCS



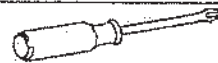

TOOLS REQUIRED(NOT PROVIDED)

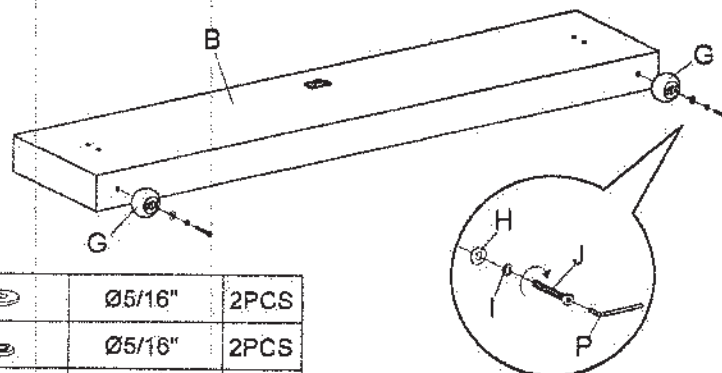

Phillips Screwdriver

Step1: Assembly FB(B) with Leg(G).



H	Flat Washer		Ø5/16"	2PCS
I	Spring Washer		Ø5/16"	2PCS
J	Bolt		Ø5/16"x2-1/2"	2PCS
P	Allen Key		M5x4"	1PC

LOCKWOOD





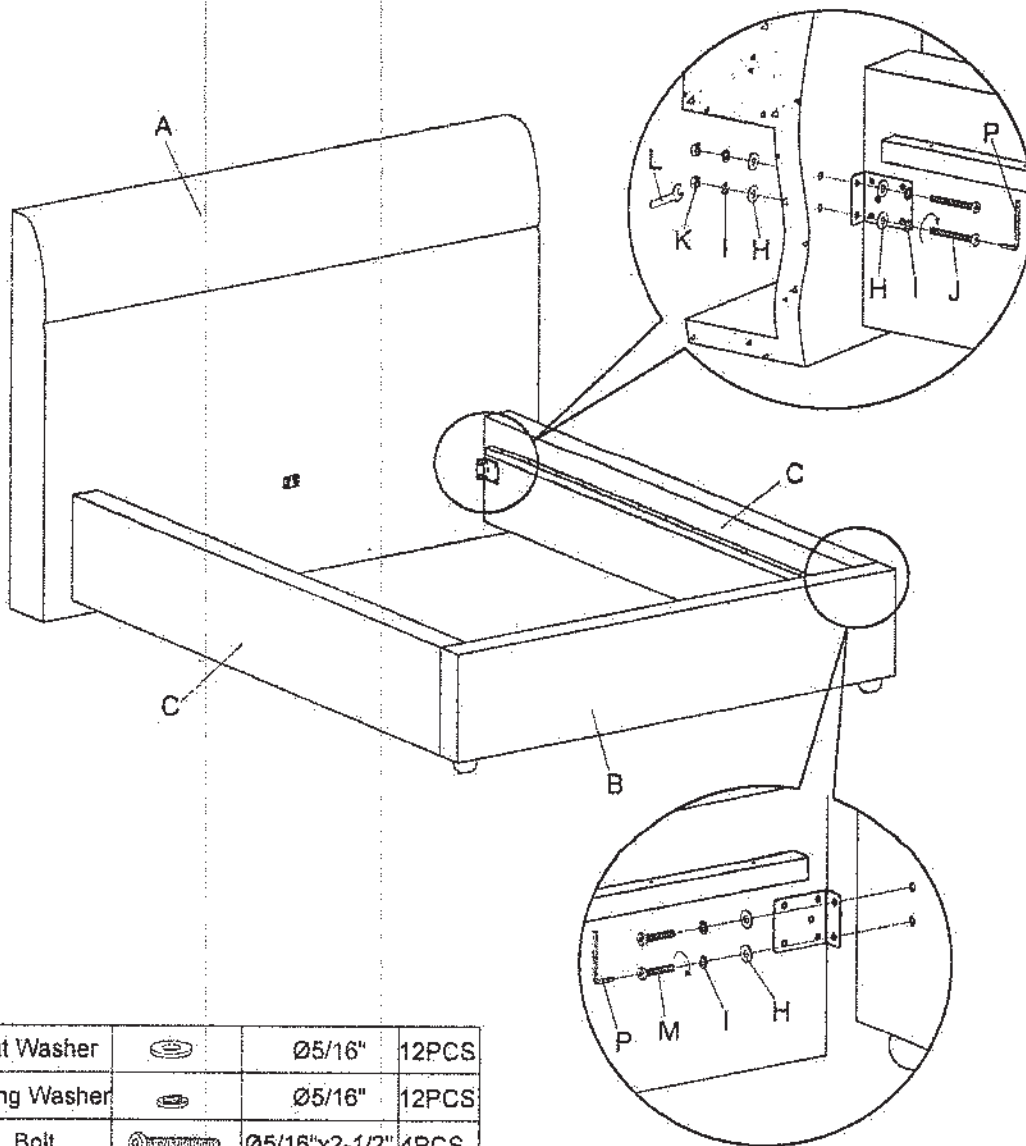

KING/QUEEN UPHOLSTERED PANEL BED

SKU: 322739, 322742

Thank you for purchasing this quality product. Be sure to check all packing material carefully for small parts that may have come loose inside the carton during shipment.

Step2: Assembly Side Rail(C) with HB(A)&FB(B).

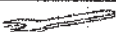
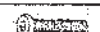





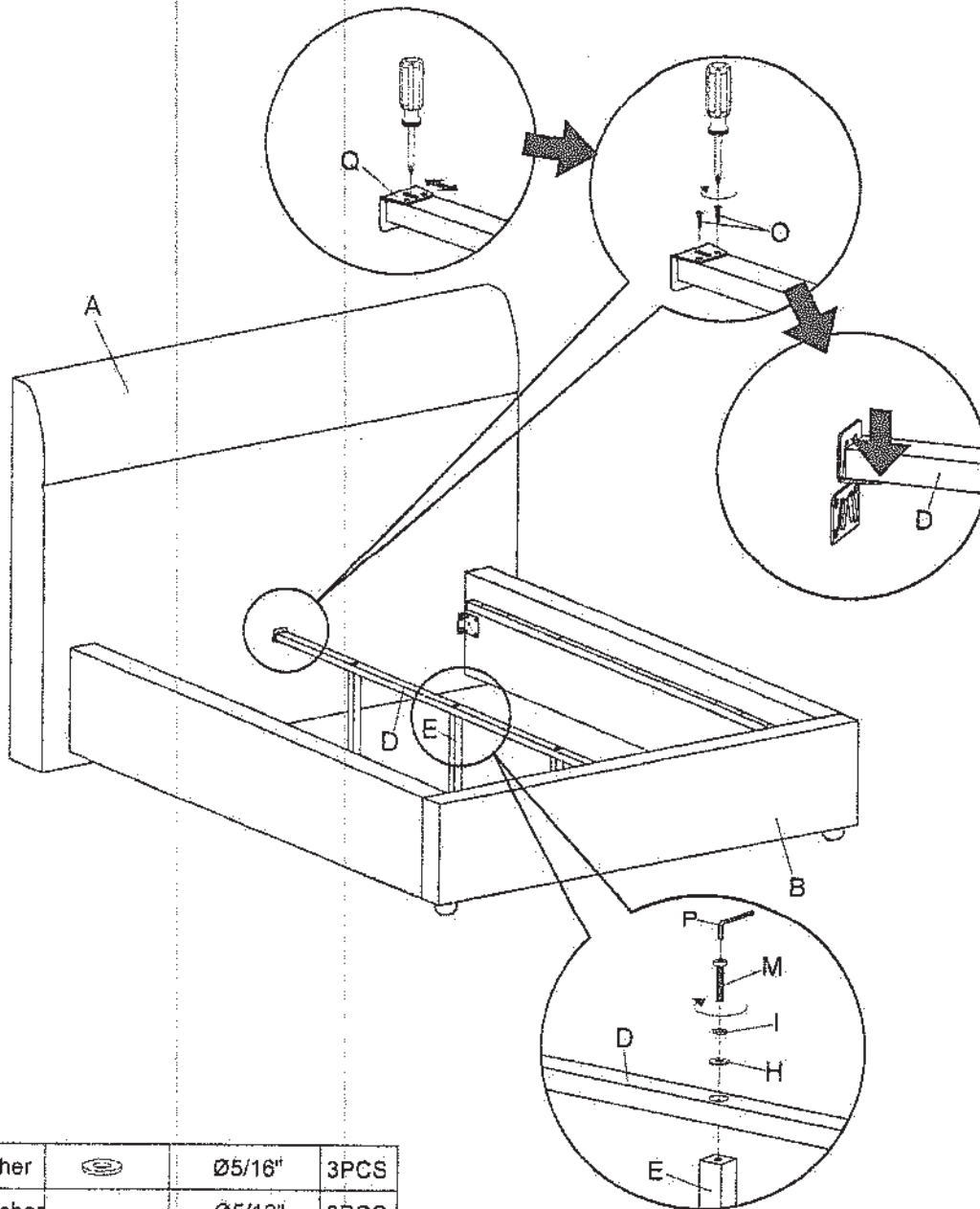

H	Flat Washer		Ø5/16"	12PCS
I	Spring Washer		Ø5/16"	12PCS
J	Bolt		Ø5/16"x2-1/2"	4PCS
K	Nut		M12	4PCS
L	Spanner		M12	1PC
M	Bolt		Ø5/16"x1-1/2"	4PCS
P	Allen Key		M5x4"	1PC

Thank you for purchasing this quality product. Be sure to check all packing material carefully for small parts that may have come loose inside the carton during shipment.

Step4: Assembly Center Rail(D) with HB(A)&FB(B).



H	Flat Washer		Ø5/16"	3PCS
I	Spring Washer		Ø5/16"	3PCS
M	Bolt		Ø5/16"x1-1/2"	3PCS
O	Screw		Ø8x3/4"	4PCS
P	Allen Key		M5x4"	1PC
Q	Metal bracket		50x32x30	2PCS

LOCKWOOD

KING/QUEEN UPHOLSTERED PANEL BED

SKU: 322739, 322742

Thank you for purchasing this quality product. Be sure to check all packing material carefully for small parts that may have come loose inside the carton during shipment.

Step4: Assembly Slats(F) with side Rail(C).

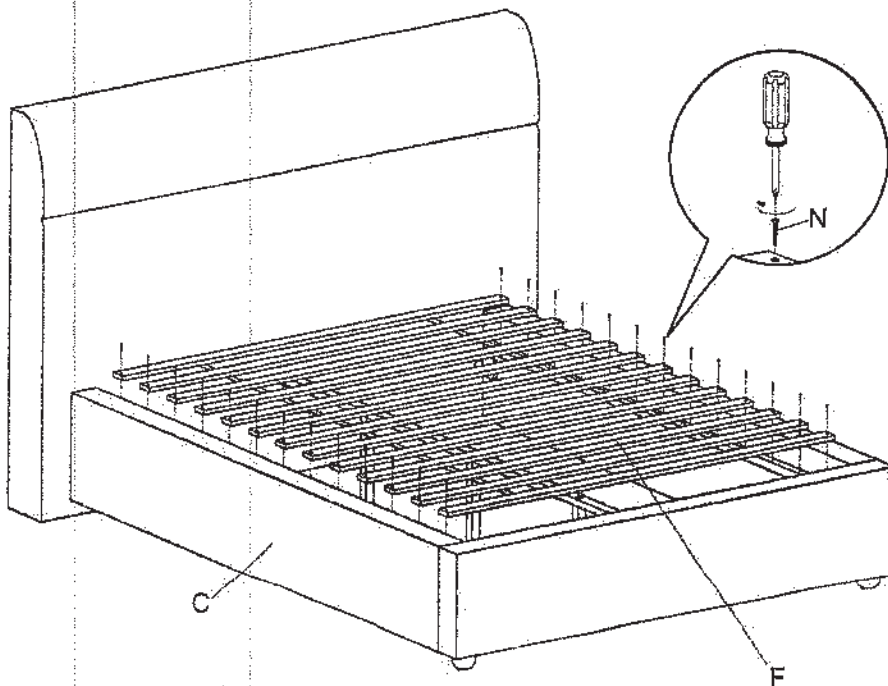

N	Screw		Ø8x1-1/2"	26PCS
---	-------	---	-----------	-------

Step5: Completed assembly for a regular bed.

