

# revive

by LIVING SPACES

**REV2500 Wireless Adjustable Base**  
**OWNER'S MANUAL**  
Installation & Operation



Patent Pending

Warranty - 2-Year Parts and Labor on entire base



## CONTENTS

Safety & Warranty Warnings	01
Parts List	04
REV2500 Electronics Quick Reference Guide	05
Installation Guide	07
REV2500 Remote Control Instructions	09
Bluetooth Instructions	11
Setting Programmable Positions and Pairing Remote	12
Setting Preset positions	13
Emergency Battery Backup	14
Synchronizing Two Bases	16
Headboard Bracket Installation Guide	17
Troubleshooting	18

## Safety & Warranty Warnings

---

*ATTENTION: READ THE FOLLOWING INFORMATION CAREFULLY BEFORE USING THIS PRODUCT*

If unable to understand warnings, cautions, and/or instructions, contact the dealer or technical personnel if applicable, before attempting to use the equipment. Otherwise, injury or damage may result.

### *SAFETY WARNINGS:*

- Do not use bed outdoors.
- Do not use bed near explosives.
- Using bed with oxygen administering equipment other than the nasal masked type creates a possible fire hazard.
- When using nasal or masked type administering equipment, route and secure oxygen or air tubing properly to ensure that tubing does not become entangled or damaged during normal operation of the bed.
- Use caution when having liquids in or around the bed to ensure no spillage occurs. In case of spillage, stand in a dry, clean area of the floor and unplug the bed immediately. Clean up spill and allow the area around bed to dry thoroughly before using the electric controls again. Do not eat or drink hot liquids while operating the bed.
- This appliance is not intended for use by persons (including children) with reduced physical, sensory or mental capabilities, or lack of experience and knowledge, unless they have been given supervision or instructions concerning use of the appliance by a person responsible for their safety.
- Do not allow children or individuals with disabilities to operate the bed without adult supervision.
- Do not allow any person or pet under the bed at any time.
- During bed operation, make sure body is positioned within the confines of the bed. Do not place extremities over the sides of the bed when operating bed functions.

*WARRANTY WARNING!*

Do not open or tamper with control box, motors, or remote (with the exception of battery compartments). The warranty will be void if the internal workings of these components are tampered with.

*Product Rating:*

The motors are not designed to operate continuously for more than [2] minutes in an [18] minute time period or approximately 10% duty cycle. Attempting to circumvent or exceed this rating will shorten the life expectancy of the foundation and may void the warranty. Operating Information:

- After power foundation assembly is completed, operate remote control to ensure proper functions.
- Keep moving parts free of obstruction during bed operation (including sheets, clothing, tubing, wiring, and products using electric power cords).
- Distribute body weight evenly over bed surface. Do not place entire weight on head or foot sections of the bed, during repositioning and entering or exiting bed.

*Hospital Use Disclaimer:*

This power foundation is designed for residential use only. It is not approved for hospital use and does not comply with hospital standards.

*Weight Limits:*

This product is not rated to support weights in excess of 850 pounds inclusive of the mattress and bedding. The bed will structurally support this weight, provided it is evenly distributed across the foundation. The power foundation is not designed to support or lift this amount in the head or foot sections alone. Exceeding this weight restriction could damage the bed and/or cause injury and will void the warranty.

*RADIO FREQUENCY:2.4 GHz*

*FCC COMPLIANCE:*

This device complies with Part 15 of the FCC Rules. Operation is subject to the following two conditions: (1) This device may not cause harmful interference, and (2) this device must accept any interference received, including interference that may cause undesired operation. To comply with the FCC RF exposure requirements, no change to the antenna or the device is permitted. Any change to the antenna or the device could result in the device exceeding the RF exposure requirement and void user's right to operate the device.

## Parts List

All electronics and components that need to be installed are located in boxes under the foundation or attached to the frame. Before discarding the packing materials, ensure that all the parts are accounted for.

A



AAA Batteries (3)

B



Bed Legs & Bottom Caps (6)

C



Power Supply (1)  
& Power Cord (1)

D



Splitter Cable(1)

E



Remote Control (1)

F



Retainer Bar (2)  
Attached to the bed frame

### OPTIONAL EQUIPMENT (NOT INCLUDED)

(2) 9-Volt Batteries



Socket and Crescent Wrench



Actual product appearance and functionality may vary from photographs.

## REV2500 Electronics Quick Reference Guide

---

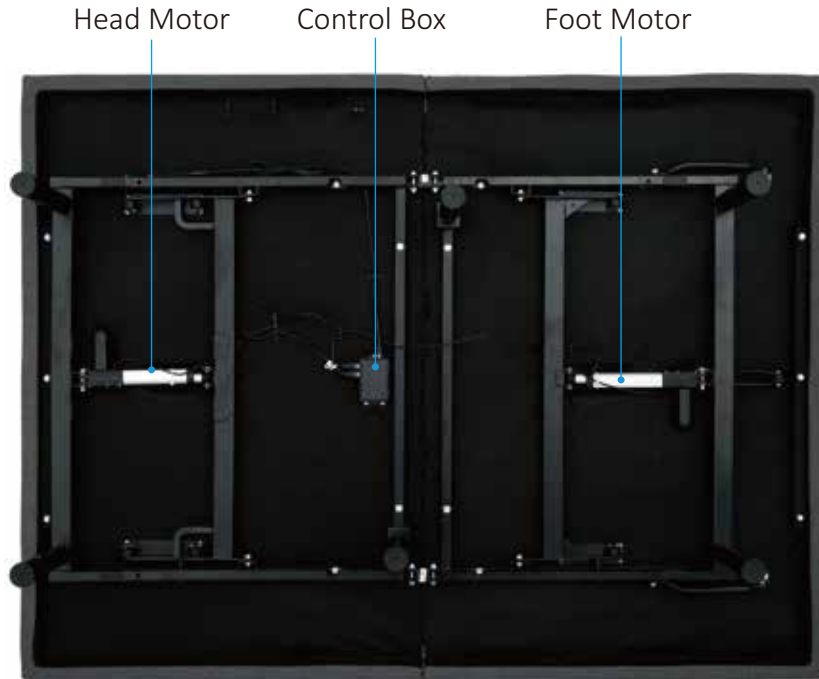



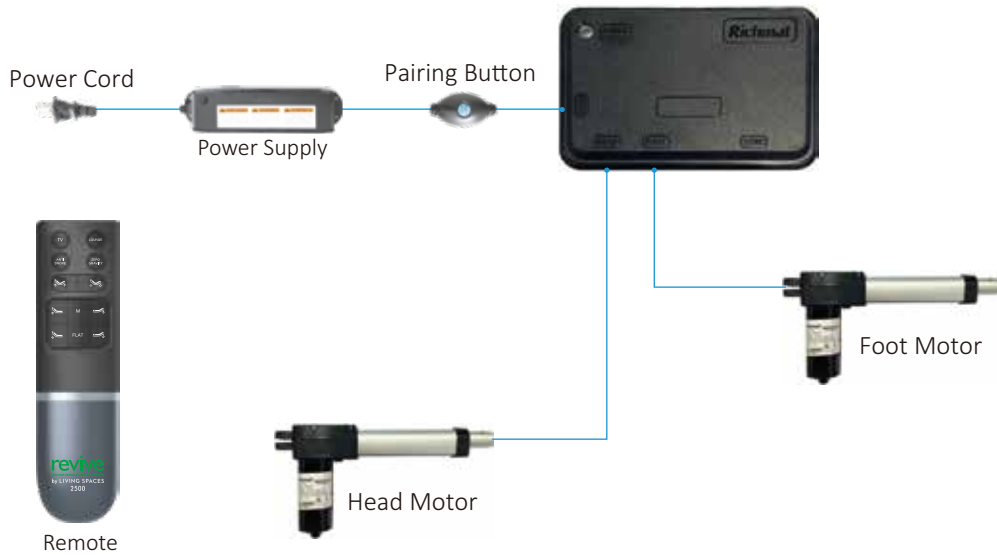

## Installation Guide

Two people are required to set up the foundation.

*NOTE: To avoid damage to the foundation, always open the carton while the bed is in the flat position.*

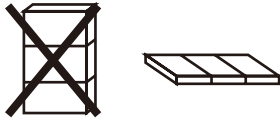

1. Open the shipping box, cut the ribbon securing accessory boxes & mattress retainer bar, and put them aside. Lift the folded bed frame unit out of the shipping carton carefully, and then put it on a flat floor.



2. To install all six legs (see image A on the bottom right), thread the bolt of the leg to the nut on the foundation frame, and tighten by hand. **DO NOT OVERTIGHTEN.**



### **WARNING**

Nut on the frame is removable and replaceable. Please remove tape on the nut to install legs.

3. Uncoil the input power cord (connected to the control box's power port) and plug it into the power supply.



4. Uncoil the power cord and connect it to the power supply.



5. Carefully flip the foundation over onto its legs.

Important: Two people are required to move the foundation.  
Do not drag across the floor. Do not rest frame on its side;  
excessive pressure may damage the legs.

6. Ensure that batteries are correctly installed.



7. Insert the mattress retainer bars into the grommets as shown.

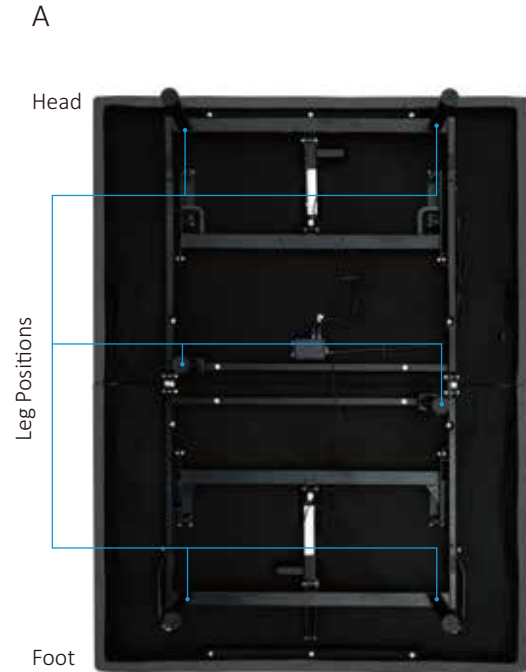

## REV2500 Remote Control Instructions



## ADJUST

---



Lifts and Lowers Head



Lifts and Lowers Foot



The double▲▲arrows lift and lower the head & foot section of the base.



## ONE TOUCH BUTTONS

---



TV preset position



Lounge Preset Position



Anti Snore Preset Position



Zero-G Preset Position



Flat Button



Memory Position

## Bluetooth Instructions

Step 1: Plug base into power source

Step 2: Turn Bluetooth on in cell phone

Step 3: Install the APP

Option 1)

Go to APP Store (IOS SYSTEM)/ Google Store (ANDROID SYSTEM)

Type "Revive Control" into search field and select APP,

press "install" to install APP onto cell phone as shown below.



Step 4: Control device via Revive APP.

- 1) Open Revive APP that was previously installed on cell phone as shown in picture below.

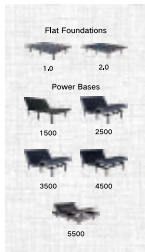

- 2) Click the  and refresh list, then select the control box code of your base (code also found on the control box affixed to your base), as shown in the picture below.

- 3) Refresh list and select the model of your base as shown in picture below.

Step 5: Open control center and select desired options.

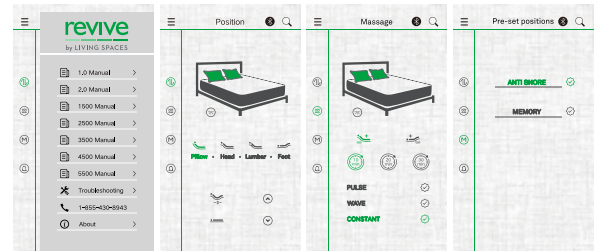

### NOTE:

If you want to re-set positions, adjust the head or foot to your desired position, then press the  of TV/ZG/Anti-Snore/M until you hear 2 beeps sound. Now, the new positions are saved.

## Setting Programmable Positions and Pairing Remote

### SETTING PROGRAMMABLE POSITIONS

The wireless power bed has a programmable feature that allows you to save custom positions.

Please read all the instructions below before setting your custom presets on the remote.

#### STEP 1

Adjust the head and foot to your desired position.



#### STEP 2

Press and hold the flat button **FLAT** first, then press and hold memory button **M** for 5 seconds until you hear 2 beeps sound.



#### STEP 3

To adjust the saved position, repeat steps 1 and 2 and the new position will be saved.

### PAIRING REMOTE

The original remote that comes in the box is already paired to the foundation. No further action is required.

In the event that the remote is not paired with the foundation, follow the steps below.



#### STEP 1

Make sure the batteries work fine. Replace them when needed.



#### STEP 2

Plug the power cord to the power source.

#### STEP 3

Press and hold head lift and foot lift simultaneously, then press and hold the button on the cord of control box for 3 seconds until you hear 2 beeps sound, the remote is then paired.



## Setting Preset positions

### SETTING PRESET POSITIONS (TV, ZG, Anti Snore)

The wireless power bed has a programmable feature that allows you to modify preset positions. Please read all the instructions below before setting your preset positions on the remote.



#### STEP 1

Adjust the head and foot to your desired position.



#### STEP 2

Press and hold the flat button **FLAT** first, then press and hold ZG or Anti Snore or Lounge button for 5 seconds until you hear 2 beeps sound.

#### STEP 3

To adjust the saved position, repeat steps 1 and 2 and the new position will be saved.

#### STEP 4

If you want to restore to factory settings, unplug the power supply for 5 seconds, then plug back in. The base will restore to factory settings.



## Emergency Battery Backup

---

### *Overview*

*Important: The backup battery is only to be used in case of a power outage. Batteries are not to be used for normal operation of the bed. The backup battery will not support repeated movement for an extended period of time.*

### *Backup Battery Use:*

Use two 9V batteries only (not included). If a power outage occurs, install the 9V batteries into the power supply to allow temporary power to the base (see image A).

### *Installing Batteries:*

Unplug the power cord from the outlet and remove the cover from the compartment on the underside of the power supply (see image B). Place two 9V batteries inside, close the cover and plug the power cord back into the wall outlet. The backup battery will not support repeated movement for extended periods of time. *After power is restored, unplug power cord, remove the batteries, then plug the power cord back into the wall for normal use.*

A



B



## Synchronizing Two Bases

### Using the Remote

If you have split bases, follow these instructions to operate both sides with one remote control in a synchronized manner.

Skip this step if you don't have split bases.

1. Make sure each remote control operates a respective side (i.e., **Remote A** controls **Base A** and **Remote B** controls **Base B**).
2. Pair **Remote A** to **Base B**, then base A and base B can be simultaneously operated by Remote A.
3. Test moving both bases with **Remote A**. **Remote B** will no longer function.

Tip: You can also set up dual controls using the included **Sync Cable**.

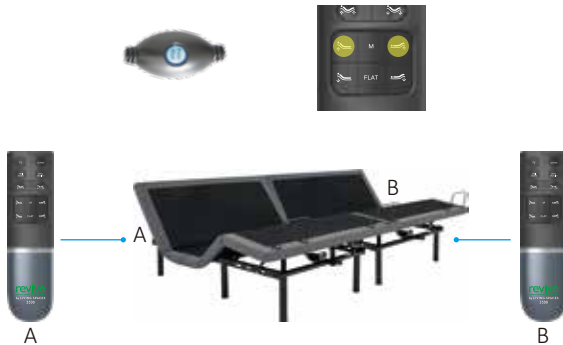

### Using the Sync Cable

As an alternative to wirelessly synchronizing bases with your remote, you can use the **Sync Cable** to synchronize two adjustable bed bases.





1. Set two bases next to each other.
2. Locate the **Sync Cable Input** on the **Control Box** of each base.
3. Plug the **Sync Cable** into each bases' **Control Box**.
4. Test the connection by moving each base with your remote control.



## Headboard Bracket Installation Guide

Headboard brackets are an optional accessory and are not included.  
A 1/2" (13 mm) socket and 1/2" (13 mm) crescent wrench are necessary to complete installation.

### HEADBOARD BRACKET COMPONENTS

(2) Headboard Brackets	(2) T-Brackets 1	(2) T-Brackets 2	(16) Short Bolts	(16) Nuts
				

#### STEP 1

The headboard bracket will have 2 long slots to accommodate any frame type. Align the appropriate slots on the bracket with the holes on the bed. Use bolts and nuts to secure the bracket. Make sure the bolts are tight.



#### STEP 2

To put the T-Bracket 1 and T-Bracket 2 together, you will need (2) bolts and (2) nuts.

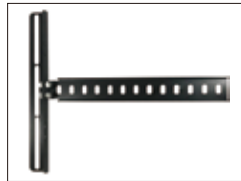

#### STEP 3

To put the T-Bracket and Headboard Bracket together, you will need (2) bolts and (2) nuts. Slip the bolts through the holes on T-Bracket to Headboard Bracket with the head of bolt facing outward. Use 1/2" (13mm) socket and 1/2" (13mm) wrench to tighten the bolts.



#### STEP 4

You may now connect your headboard to the attachment plates using the remaining bolts and nuts to secure it to the brackets. The heads of the bolts will face outward. Use a 1/2" (13 mm) socket and 1/2" (13 mm) wrench to tighten the bolts.

## Troubleshooting

In the event that the power foundation fails to operate, assess the symptoms and possible solutions provided in the chart below.

SYMPTOMS	SOLUTIONS
Remote control illuminates and appears to be operable, but will not activate bed.	Verify that the power cord is plugged into a working, grounded electrical outlet. Test the outlet by plugging in another working appliance.
No features of the power foundation will activate.	<p>Program the remote control (see the Setting Programmable Positions and Pairing Remote section of this manual for programming procedures).</p> <p>Unplug the power cord, wait 30 seconds and plug back to reset electronic components.</p> <p>The surge protection device or the electrical outlet may be defective. Test the outlet by plugging in another working appliance.</p> <p>Verify that the connector on the wired remote control is securely attached to the control box.</p>
Wireless remote will not illuminate.	Replace the batteries in the wireless remote.
Head or foot section will elevate, but will not return to the horizontal (flat) position.	<p>Bed mechanism may be obstructed. Elevate bed and check for obstruction. Remove obstruction.</p> <p>Head section may be too close to the wall.</p> <p>Headboard may be too close to the edge of the mattress. Verify that there is enough distance between the headboard brackets and mattress. Adjust if required.</p>

In the event that the power foundation fails to operate, assess the symptoms and possible solutions provided in the chart below.

SYMPTOMS	SOLUTIONS
Head & Foot lift function has minor interference during operation.	<p>Check batteries in wireless remote control, replace with two (2) new AAA batteries if necessary.</p> <p>Make sure that you are following the duty cycle of the motors (do not operate more than two minutes over a 18-minute period, or approximately 10% duty cycle).</p> <p>Press the lift buttons squarely and accurately.</p> <p>Wireless remote control may be experiencing common Radio Frequency Interference from other radio transmitting devices. Wait several seconds, and then try pressing appropriate button again, See FCC Compliance Statement on page 5 of this guide.</p>
A clicking noise is heard under the bed when raising or lowering.	This is normal. The lift motor relays “click” when they are engaged. No action is required.



revive



by LIVING SPACES

Customer Service: 1-855-430-8943  
Serial No.