



LIVING SPACES

# Assembly Instruction For

ALTON CHERRY II ROUND DINING TABLE





ITEM: DTMIDTRDT2C SKU#: 320267



CAUTION: PLEASE READ ALL INSTRUCTION BEFORE STARTING THE ASSEMBLY OF THIS PRODUCT. THESE ARE HEAVY. IN ORDER TO PREVENT PERSONAL INJURY AND ENSURE THAT THIS PRODUCT IS NOT DAMAGED DURING THE ASSEMBLY PROCESS. IT IS STRONGLY RECOMMENDED THAT YOU ENLIST THE ASSISTANCE OF ONE OR MORE PEOPLE.

CUIDADO: FAVOR DE LEER TODAS LAS INSTRUCCIONES MANTES DE ENSAMBLAR SU PRODUCTTO. ESTAS PIEZAS SON PESADAS. PARA PREVENIR HERIDAS PERSONALES Y ASEGURAR QUE SU PRODUCTOI NO SEA DAN ADO MIENTRAS ES ANSAMBLADO, SE RECOMIENDA LA ASISTENCIA DE UNA O MAUS PERSONAS.

WARNING.....PROTECTIVE GLIDE IS PLACED UNDER LEGS OF FURNITURE TO RESIST SCRATCHES TO FLOOR SURFACE. SOME FLOOR SURFACES CAN BE EXTRA SENSITIVE TO MARKING. IF YOU ARE NOT SURE CONSULT WITH YOUR DEALER.

AVERTISSEMENT...LES PIEDS DES MEUBLES SONT MUNIS DE PAINTS DESTINÉS À PROTÉGER LE PLANCHER. CERTAINS REVÊTEMENTS DE SOL PEUVENT ÊTRE TRÈS FRAGILES. EN CAS DE DOUTE, CONSULTER LA MARCHAND.

NO.	Hardware List	Q' TY
1	 Hex Nut (Ø5/16*12mm)	8
2	 Spring Washer Ø5/16*13mm	8
3	 Flat Washer Ø5/16*19mm	8
4	 Allen Wrench(M12*59mm)	1

NO.	Parts list	Q' TY
A	 Alton Cherry II Round Dining Table Top	1
B	 Alton Cherry II Round Dining Table Leg	4

## Step 1

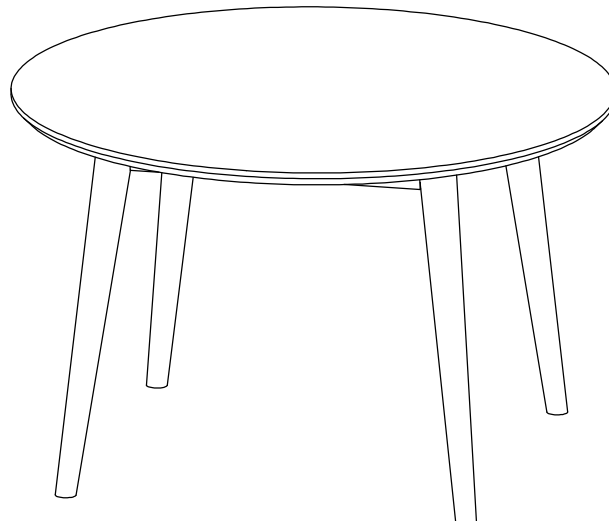
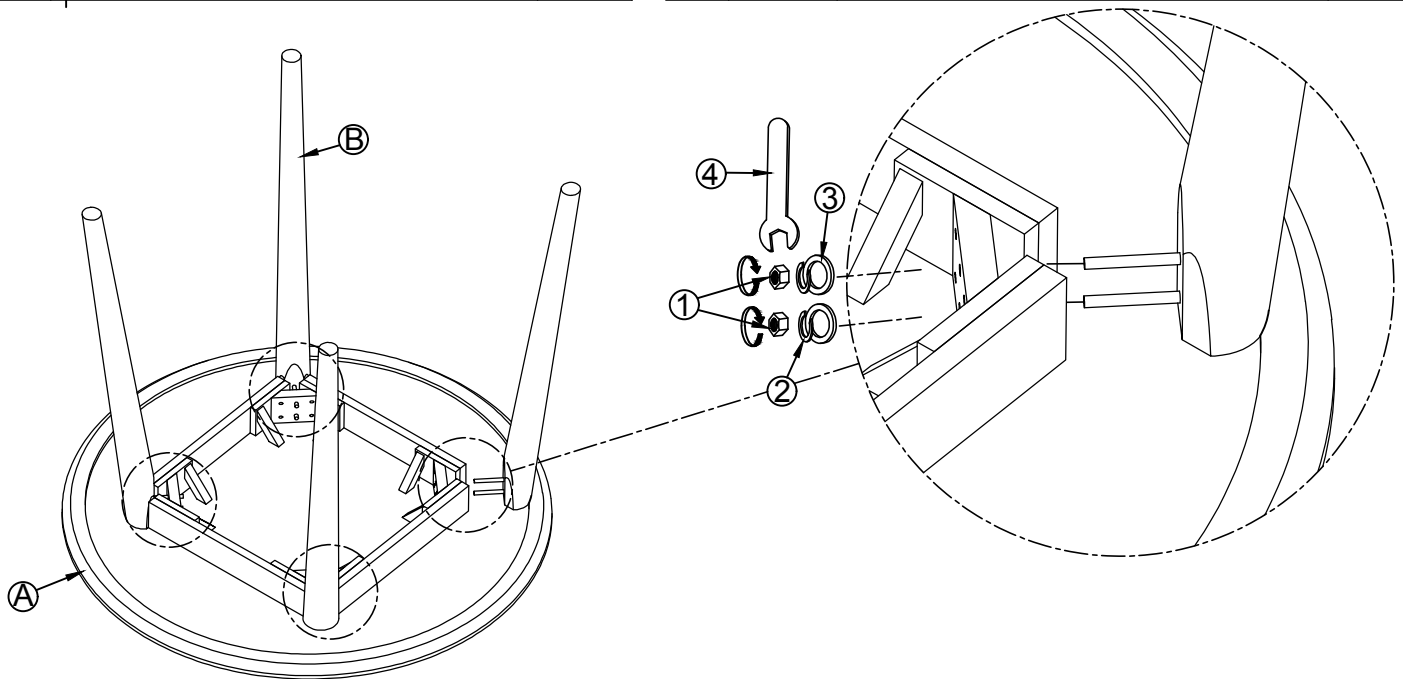

Assembly completed  
Made in Vietnam