



LIVING SPACES

ASSEMBLY INSTRUCTIONS

AUSTEN 3 DRAWER NIGHTSTAND
ITEM NO: B2101-103

SKU:318008

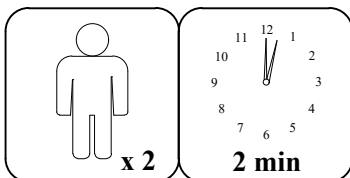
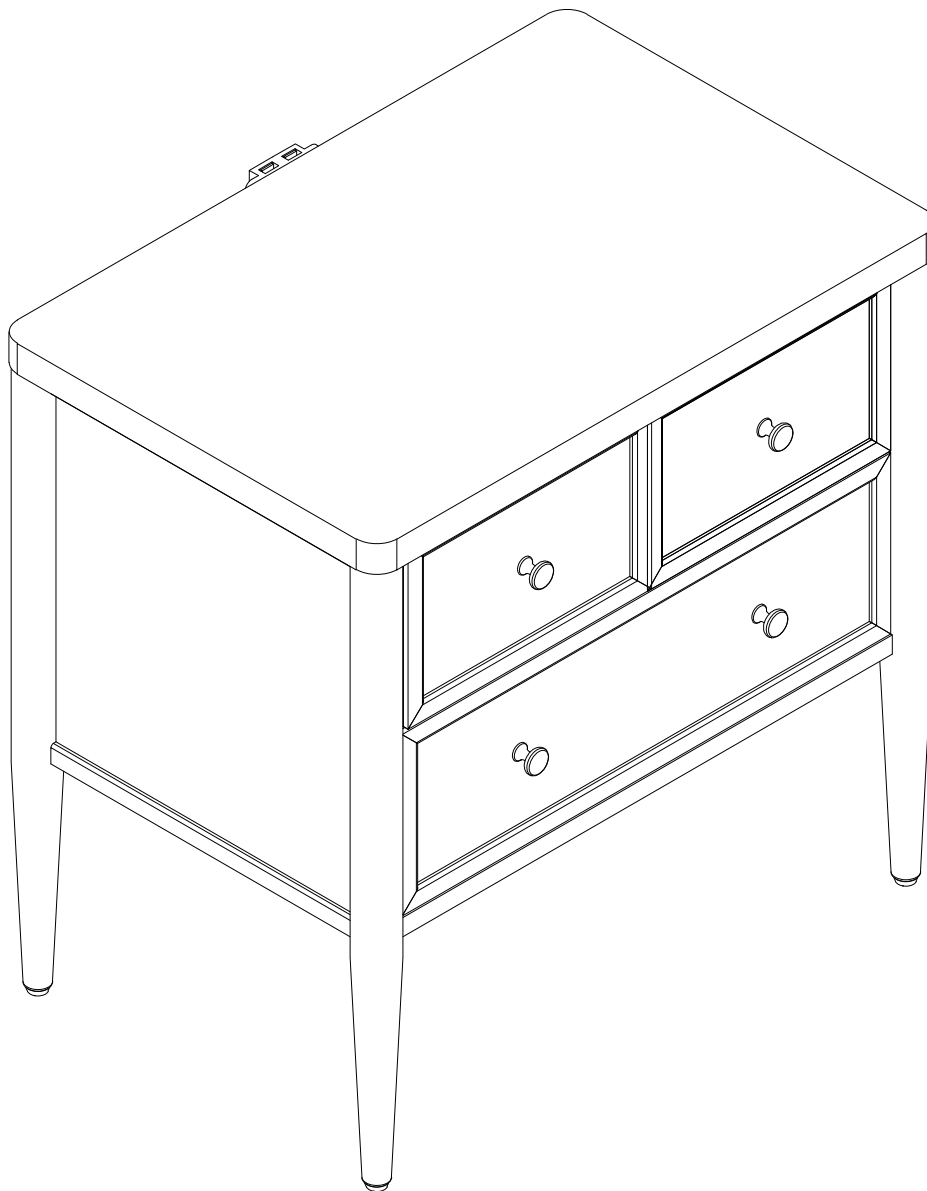



x 2

2 min

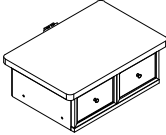
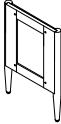
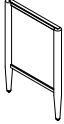
1

| PART | SKU# | IMAGE | DESCRIPTION | QTY |
|-------------|---------------|---|---------------------------|------------|
| (A) | 318008 |  | Desk Top | 1 |
| (B) | 318008 |  | End assembly Right | 1 |
| (C) | 318008 |  | End assembly Left | 1 |

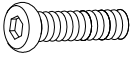
Hardware List

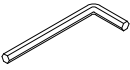
| PART | SKU# | IMAGE | DESCRIPTION | QTY |
|-------------|---------------|---|----------------------------|------------|
| (1) | 318008 |  | Bolts 1/4" *35mm | 8 |
| (2) | 318008 |  | Spring Washer 1/4"*11mm | 8 |
| (3) | 318008 |  | Flat Washer 1/4"*19mm | 8 |
| (4) | 318008 |  | Allen key | 1 |

THE HARDWARE IS LOCATED IN THE PACKING ITEM

**MUST: TIGHTEN SCREWS PERIODICALLY. WITH USE SCREW
MAY ENCOME LOOSE CHECK TIGHTNESS OF ALL SCREWS EVERY 6-8
WEEKS.**

CLEANING INSTRUCTIONS:

**After assembly, clean and polish the completed parts if necessary with
soft cloth and industrial recognized furniture polish.**

STEP 1

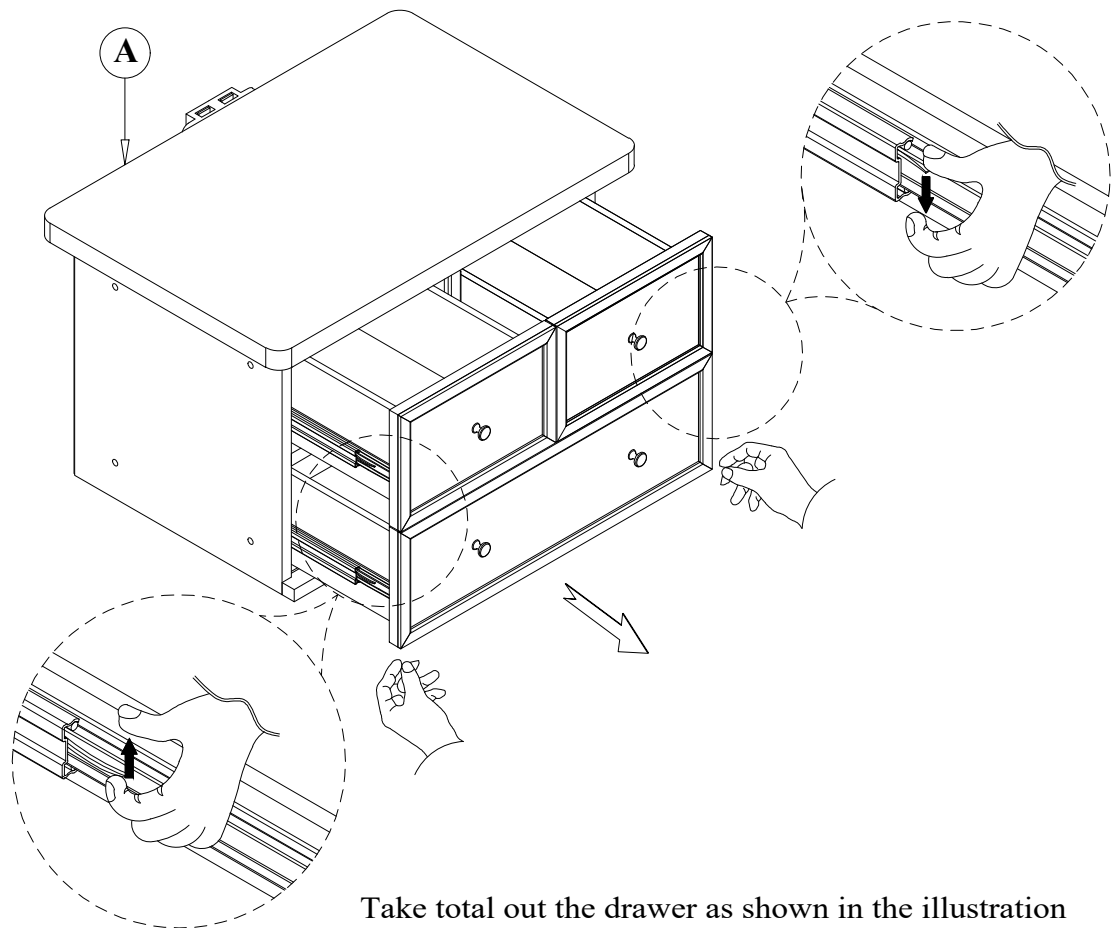

Take total out the drawer as shown in the illustration

STEP 2

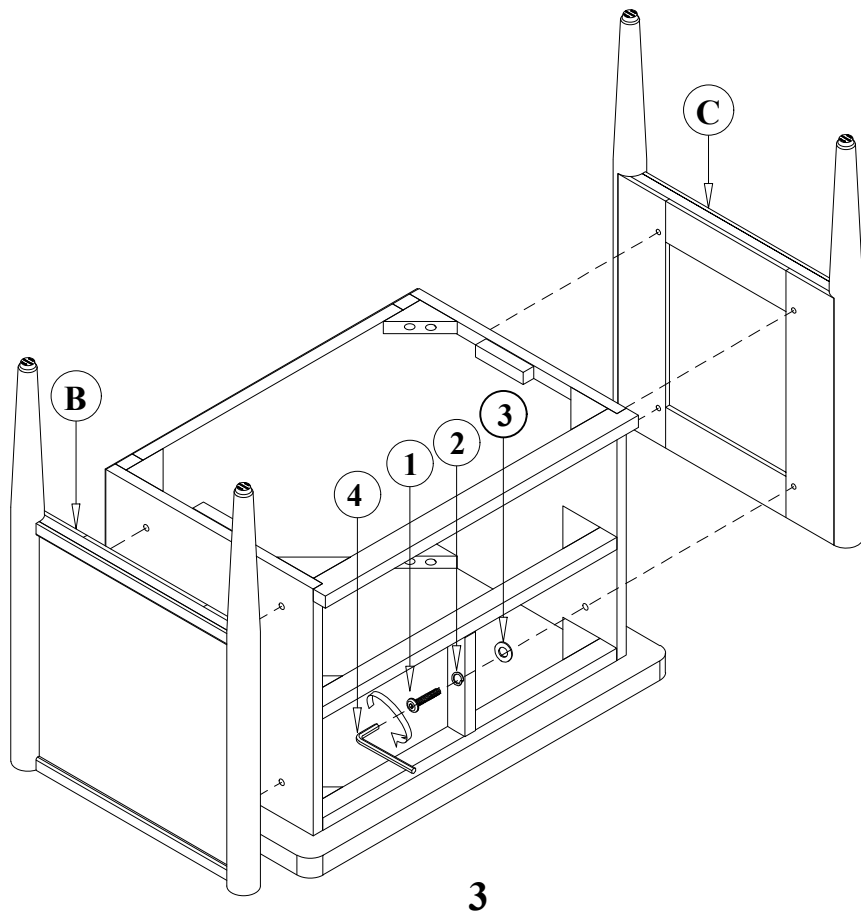

1=8pcs
2=8pcs
3=8pcs

3

STEP 3

Install the drawer back as shown in the illustration.

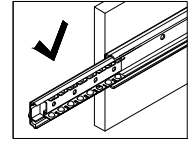
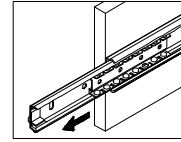
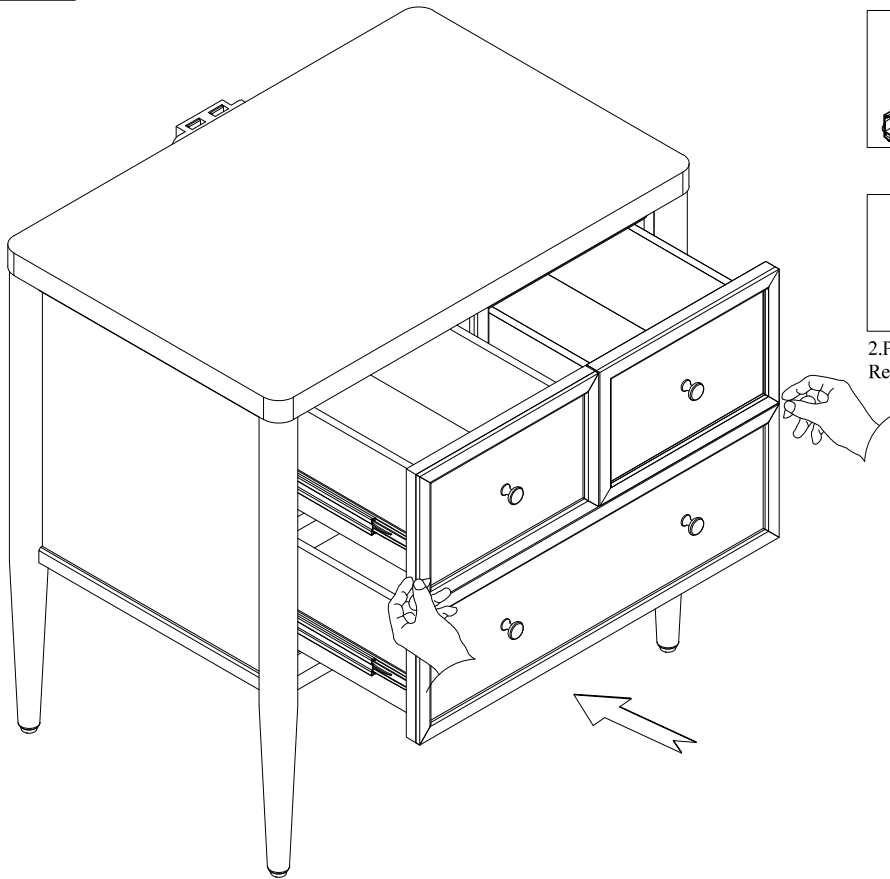

1. Pull out slide. Slide bearings forward

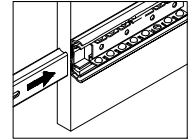
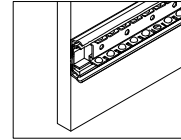

2. Push slide back inside.
Repeat for every slide

3. Insert into slide
slot correctly push
the drawer into the
table body with force

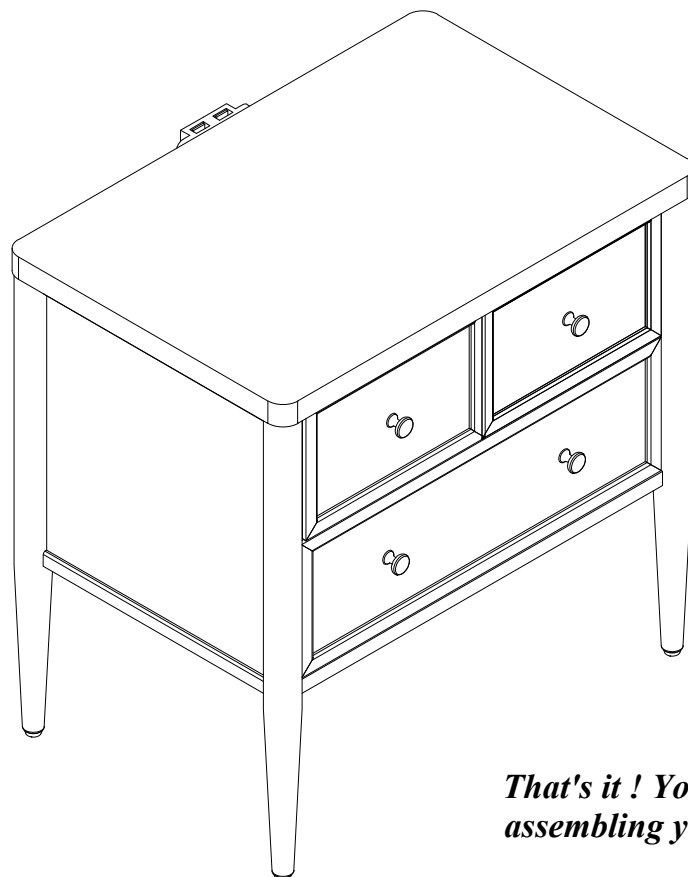

***That's it ! You've finished
assembling your item. Thank you!***