



LIVING SPACES

# ASSEMBLY INSTRUCTIONS

**AUSTEN 1 DRAWER NIGHTSTAND**  
**ITEM NO: B2101-101**

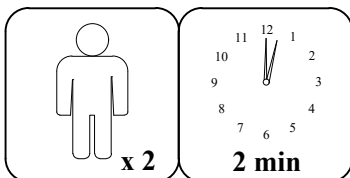
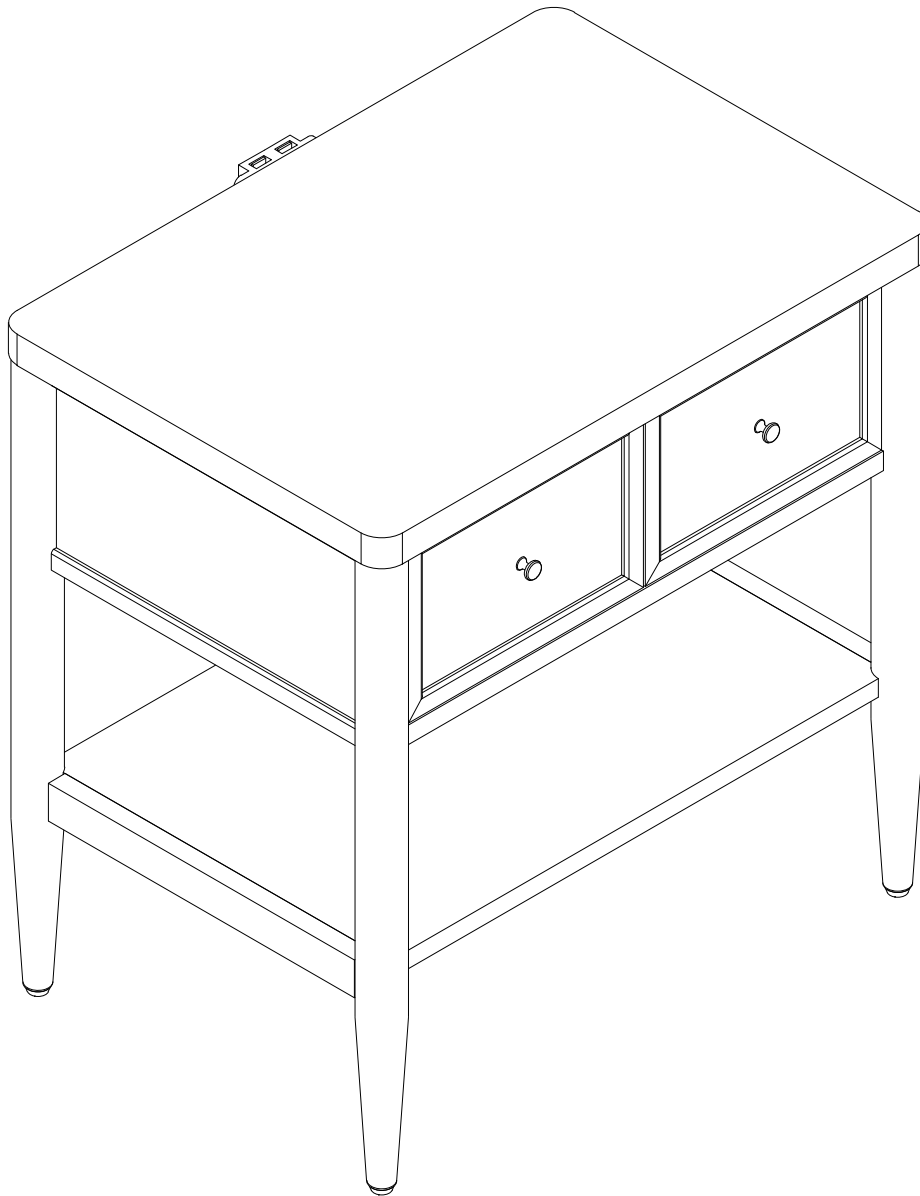

**SKU:318007**





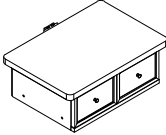
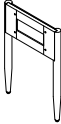

x 2

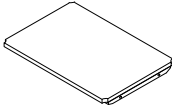
2 min

**1**

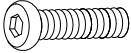
<b>PART</b>	<b>SKU#</b>	<b>IMAGE</b>	<b>DESCRIPTION</b>	<b>QTY</b>
<b>(A)</b>	<b>318007</b>		<b>Desk Top</b>	<b>1</b>
<b>(B)</b>	<b>318007</b>		<b>End assembly Right</b>	<b>1</b>
<b>(C)</b>	<b>318007</b>		<b>End assembly Left</b>	<b>1</b>
<b>(D)</b>	<b>318007</b>		<b>Shelf</b>	<b>1</b>

#### **Hardware List**

<b>PART</b>	<b>SKU#</b>	<b>IMAGE</b>	<b>DESCRIPTION</b>	<b>QTY</b>
<b>(1)</b>	<b>318007</b>		<b>Bolts 1/4" *35mm</b>	<b>12</b>
<b>(2)</b>	<b>318007</b>		<b>Spring Washer 1/4"*11mm</b>	<b>12</b>
<b>(3)</b>	<b>318007</b>		<b>Flat Washer 1/4"*19mm</b>	<b>12</b>
<b>(4)</b>	<b>318007</b>		<b>Allen key</b>	<b>1</b>

#### **THE HARDWARE IS LOCATED IN THE PACKING ITEM**

**MUST: TIGHTEN SCREWS PERIODICALLY. WITH USE SCREW  
MAY ENCOME LOOSE CHECK TIGHTNESS OF ALL SCREWS EVERY 6-8  
WEEKS.**

#### **CLEANING INSTRUCTIONS:**

**After assembly, clean and polish the completed parts if necessary with  
soft cloth and industrial recognized furniture polish.**

**STEP 1**

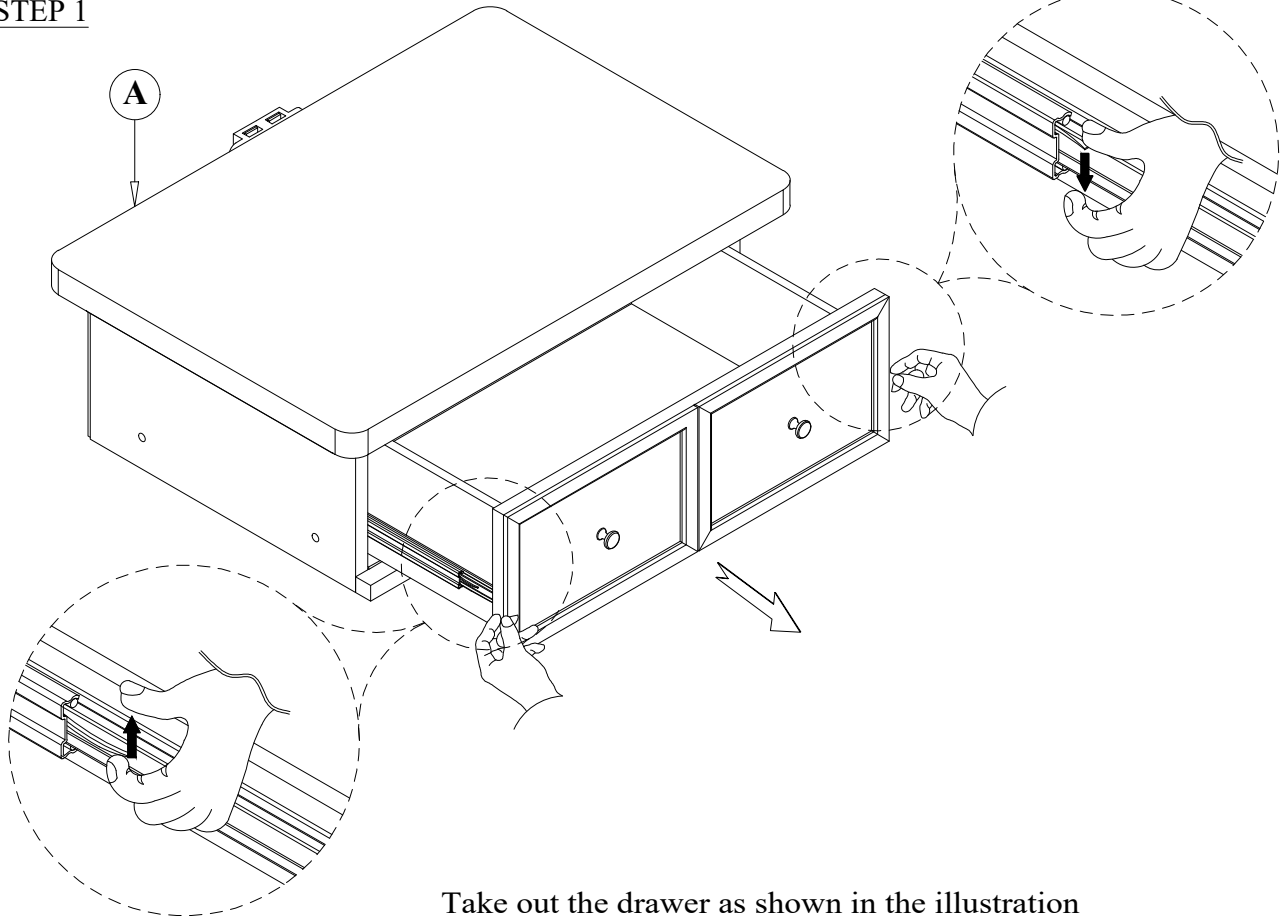

Take out the drawer as shown in the illustration

**STEP 2**

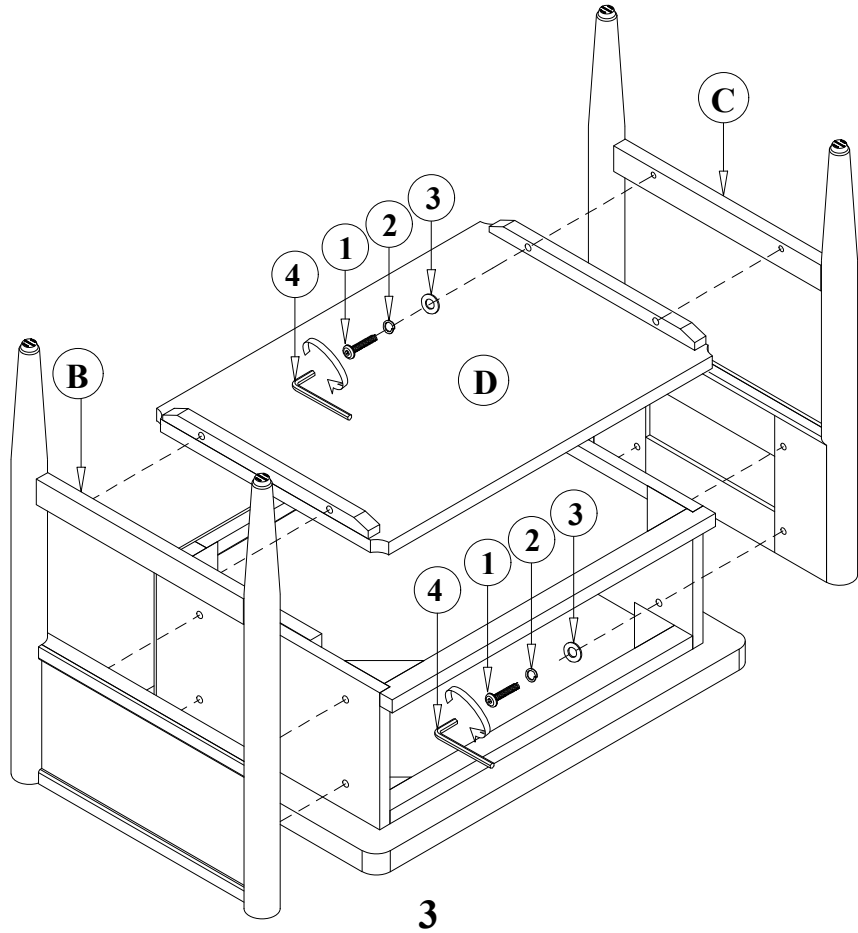

1=12pcs  
2=12pcs  
3=12pcs

**STEP 3**

Install the drawer back as shown in the illustration.

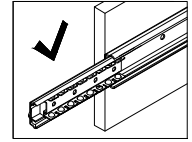
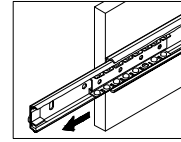
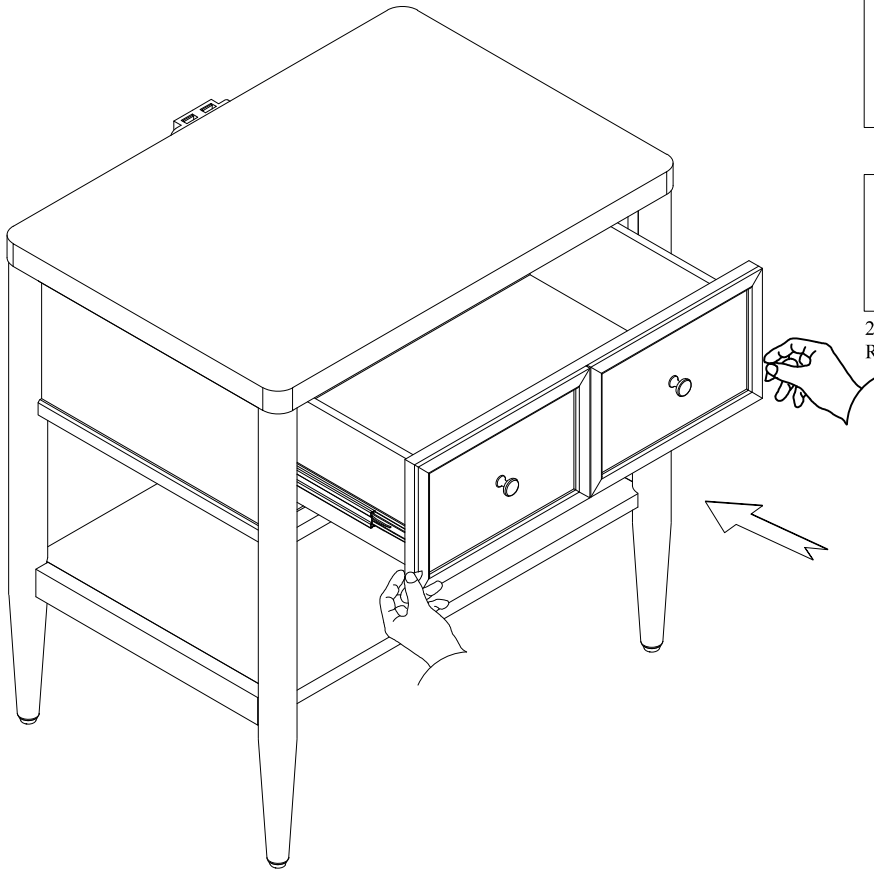

1. Pull out slide. Slide bearings forward

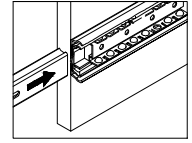
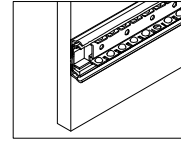

2. Push slide back inside.  
Repeat for every slide

3. Insert into slide slot correctly push the drawer into the table body with force

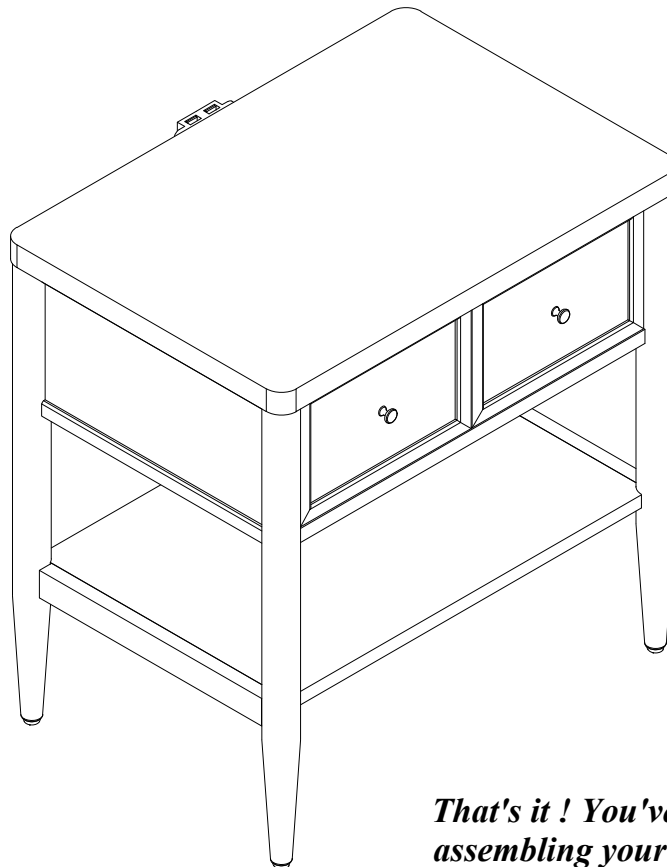

***That's it ! You've finished assembling your item. Thank you!***