







Vendor Information	
Vendor Name:	LSMX1
Vendor Code:	V-005852

Living Space Information	
LS SKU:	317507
LS product Name:	CELESTINO SLATE ACCENT CHAIR
Vendor Model #:	1520-ACH-CE-SLA
Vendor Collection:	CELESTINO

CODE	PART #	DESCRIPTION	SHIPS IN 48 HRS	QUANTITY	PRICING	NOTES
A	LEGCALIS	WOOD LEG CALISTO	YES	4		
B	SCRW5161	SCREW BUTTON HEAD CAP	YES	20		
C	WHR51618	WASHER 5/16 PLAIN	YES	20		
D	ALLEN316	3/16 SHORT ARM HEX KEY	YES	1		

LIVING SPACES		
A	LEGCALIS	 X4
B	SCRW5161	 X20
C	WHR51618	 X20
D	ALLEN316	 X1
1		 X1

ACCENT CHAIR

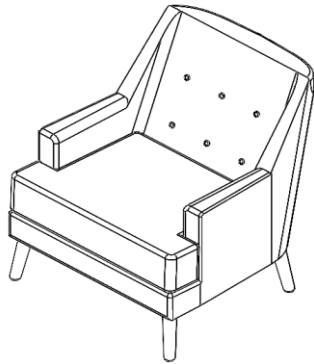

STEP 1:

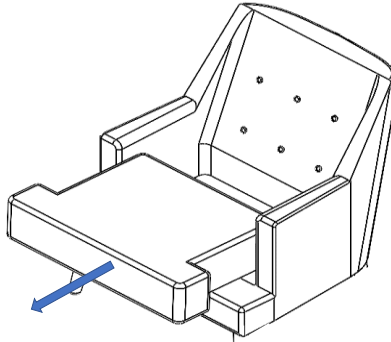

REMOVE CUSHIONS

STEP 2:

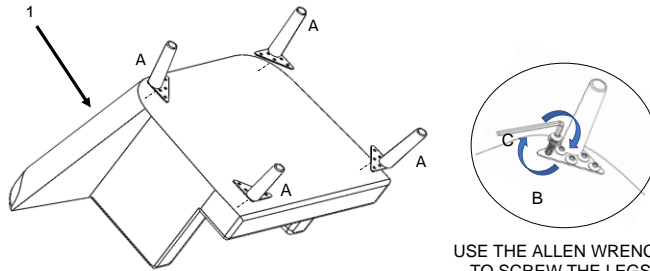

USE THE ALLEN WRENCH TO SCREW THE LEGS

