

ASSEMBLY INSTRUCTION

STEP
1

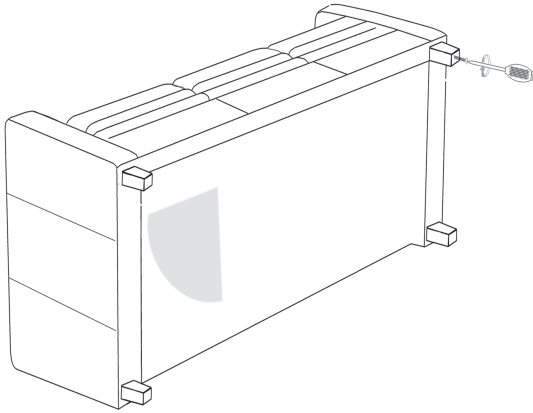

Install Legs

ASSEMBLY INSTRUCTION

STEP
3

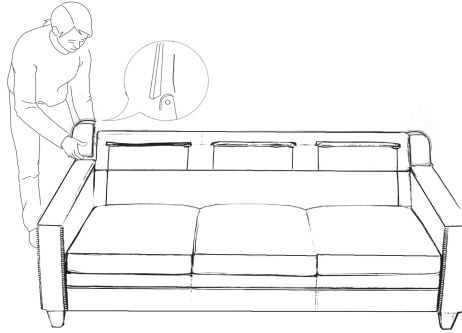

Install wings

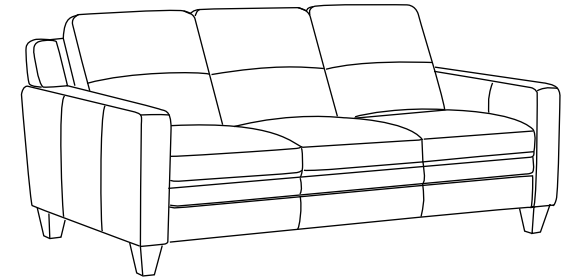

STEP
2

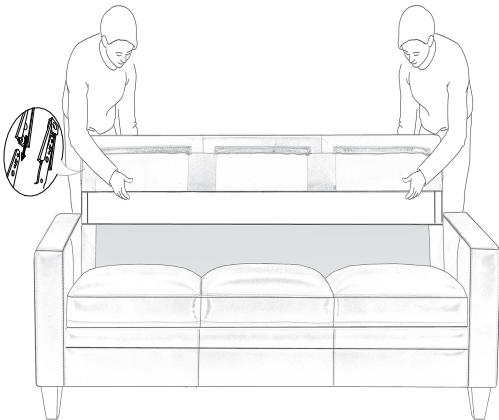

Install Backrest



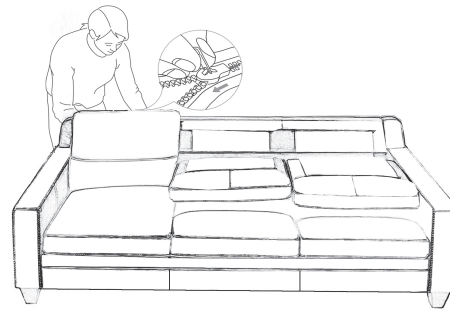





STEP
4



Install back cushions

- Before you begin the assembly of your new furniture, please insure that all the parts are present.
- Follow instructions closely as deviation may void your warranty and create a potential safety risk.
- It is recommended that assembly is done on a soft surface to avoid damage.

ASSEMBLY INSTRUCTION

A	Backrest X1			
B	Sofa Body X1		G	Back Cushion X3 
C	Left wing X1		H	Bolt X4 
D	Right wing X1		I	Washer X4 
E	Wooden leg-1 X4		J	Washer X4 

Fittings And Parts Checklist

Display Diagram

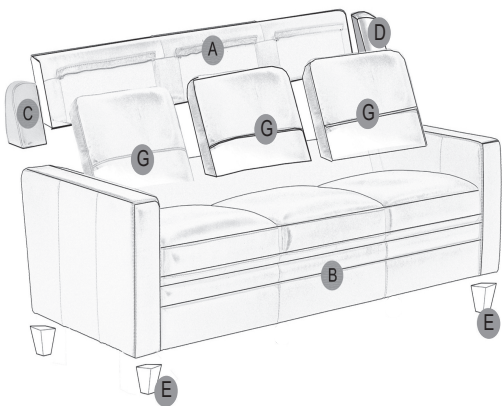

ASSEMBLY INSTRUCTION

How to Find Your Furniture Legs Cómo encontrar las patas de su mueble

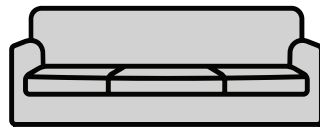

Gently lay sofa/love seat on it's back
Coloque suavemente el sofá o el sofá de dos plazas sobre su respaldo

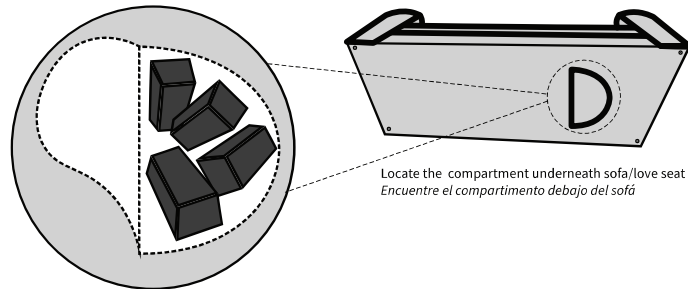

Locate the compartment underneath sofa/love seat
Encuentre el compartimento debajo del sofá

Open compartment to locate upholstery legs and assembly instructions
Habrà el compartimento para localizara las patas del sofá y las instrucciones de asamblea



ASSEMBLY INSTRUCTION

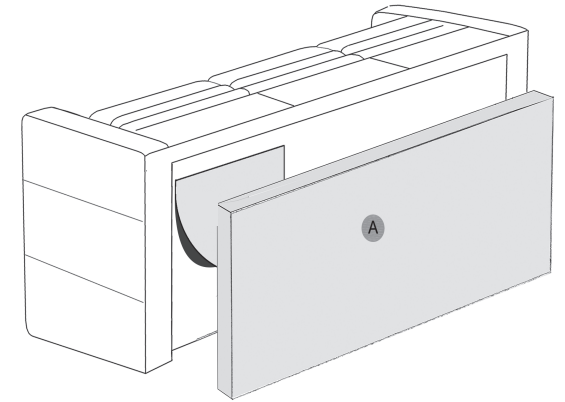

The backrest be packaged at the bottom of the sofa,take it down

Fittings

