

# ARGENTO MIRROR ASSEMBLY INSTRUCTIONS



## PARTS PACKING CONFIGURATIONS

### BOX #1

A. DRESSER(SOLD SEPARATELY): 1PC

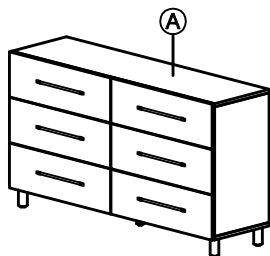

### BOX #2

B. MIRROR: 1PC  
C. SUPPORT BAR: 2PCS  
\*MIRROR HARDWARE PACK

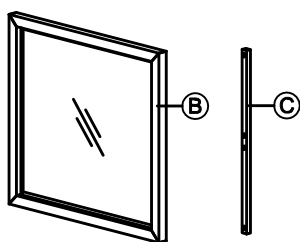

### HARDWARE PACKED IN BOX #2

1	ALLEN BOLT (6x50mm)		8PCS
2	SPRING WASHER (M8)		8PCS
3	FLAT WASHER (M8)		8PCS
4	ALLEN KEY		1PC

### OPTION 1 : ATTACHING MIRROR TO DRESSER

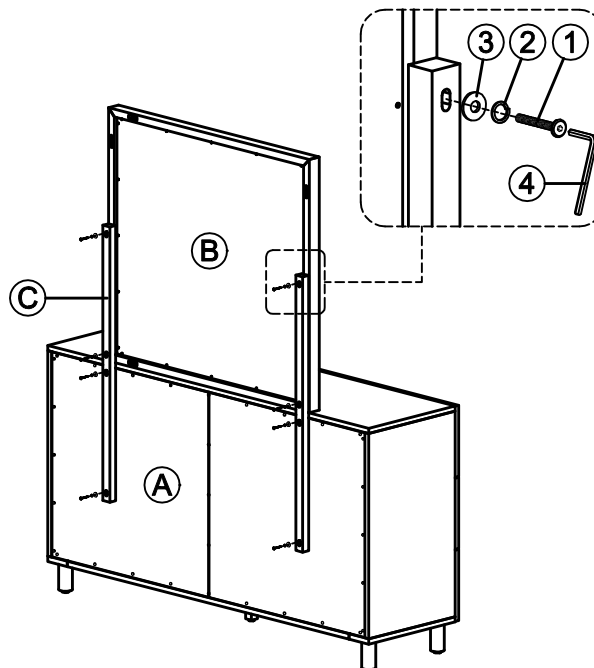

### OPTION 2 : ATTACHING MIRROR TO WALL

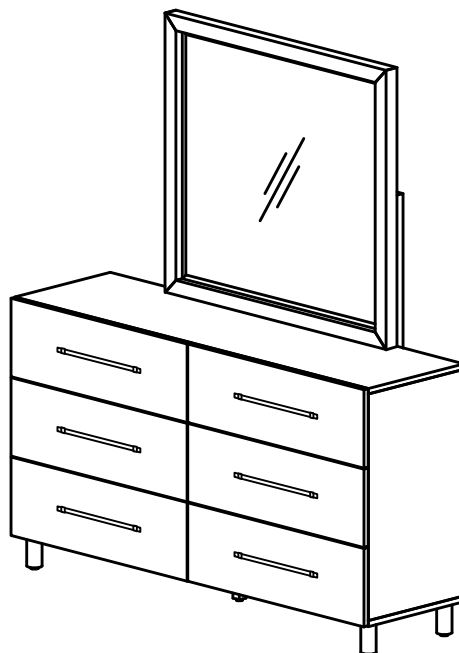
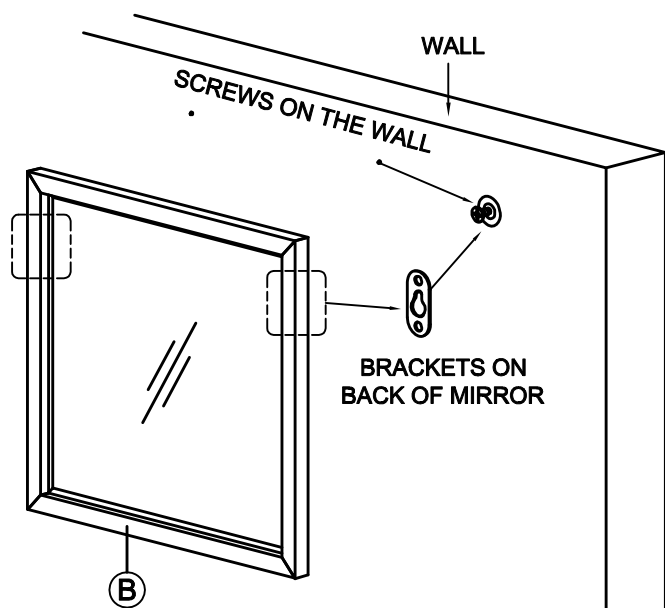

MOUNTING HARDWARE IS NOT INCLUDED.

TOOL REQUIRED :  
PHILLIPS-HEAD SCREW DRIVER (NOT PROVIDED)

