

PARTS LIST

No.	DESCRIPTION	IMAGE	Q'TY
A	SOFA SEAT		1
B	BACK CUSHION		3
C	PILLOW		2
D	SEAT CUSHION		3
E	LEG		5

NOTE: PO # is located underneath/ at the back side of each item. Please be prepared to provide this # should any claim be necessary.

CAUTION: Item is heavy. Assembly should be performed by two people.

1

Take the Leg out of the bottom

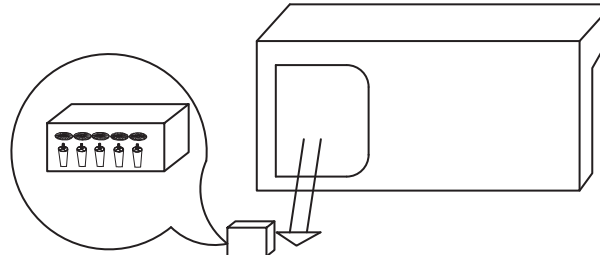

2

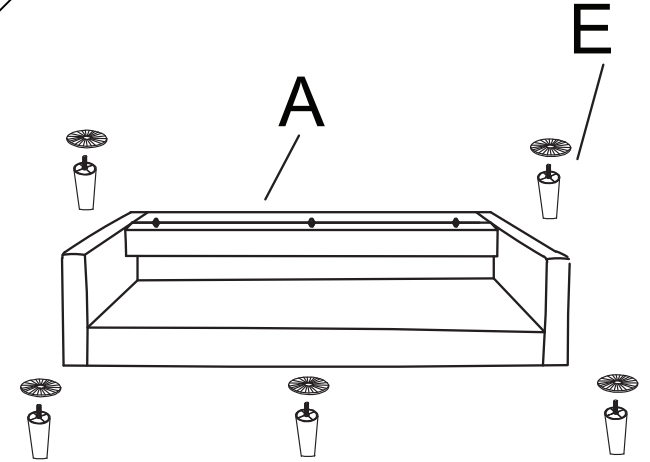

3

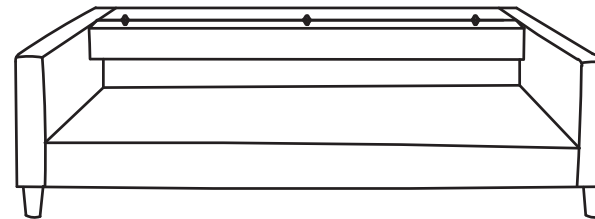





D

KIT-STARK LIGHT GREY SOFA & LIGHT GREY SWIVEL CHAIR

313191

Assembly instructions:

PARTS LIST

No.	DESCRIPTION	IMAGE	Q'TY
A	SOFA SEAT		1
B	BACK CUSHION		3
C	PILLOW		2
D	SEAT CUSHION		3
E	LEG		5

NOTE: PO # is located underneath/ at the back side of each item. Please be prepared to provide this # should any claim be necessary.

CAUTION: Item is heavy. Assembly should be performed by two people.

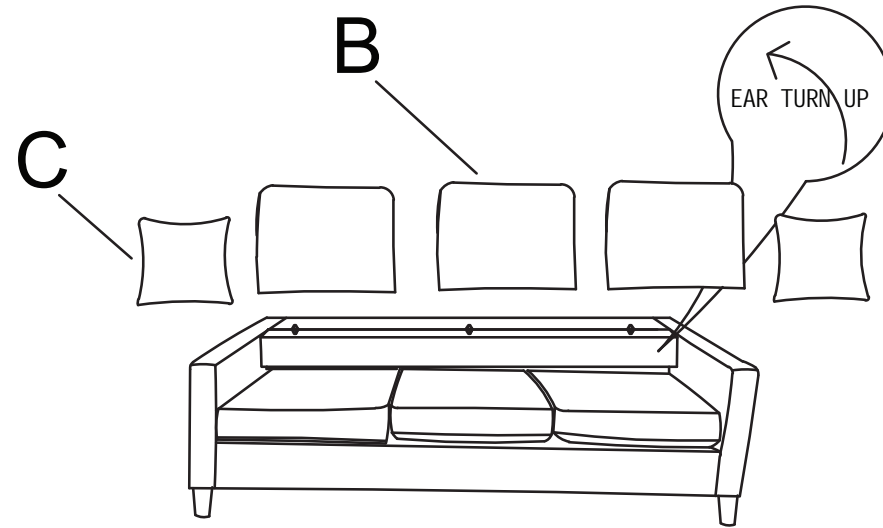

4

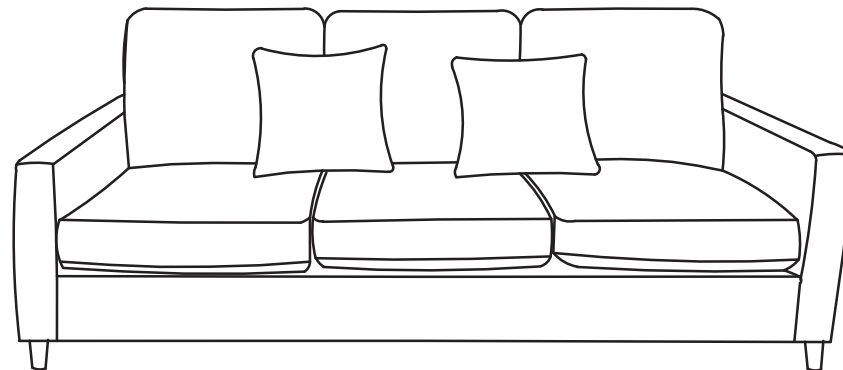

5

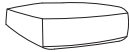

PARTS LIST

No.	DESCRIPTION	IMAGE	Q'TY
A	BACK		1
B	SEAT CUSHION		1
C	SEAT		1

NOTE: PO # is located underneath/ at the back side of each item. Please be prepared to provide this # should any claim be necessary.

CAUTION: Item is heavy. Assembly should be performed by two people.

1

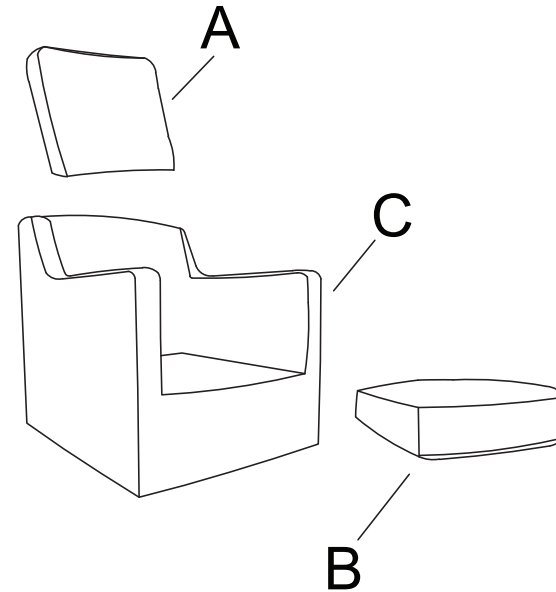

2

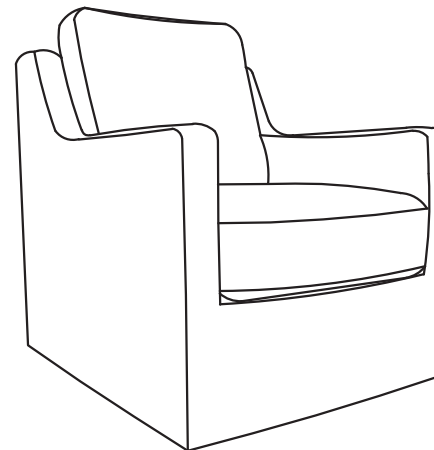

How to Find Your Furniture Legs *Cómo encontrar las patas de su mueble*

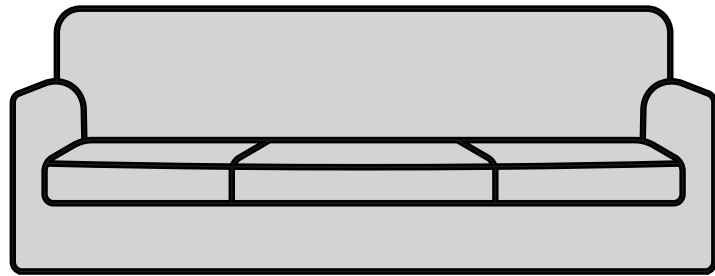

Gently lay sofa/love seat on it's back
Coloque suavemente el sofá o el sofá de dos plazas sobre su respaldo

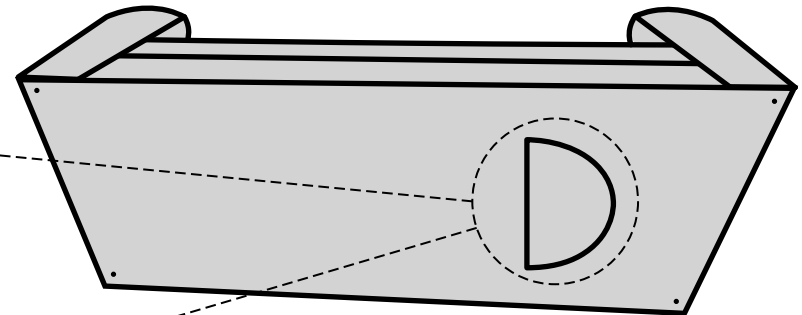
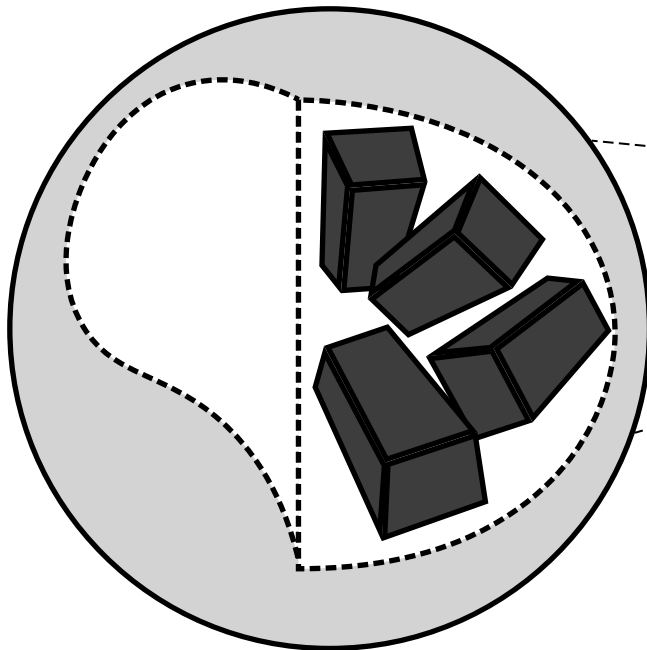

Locate the compartment underneath sofa/love seat
Encuentre el compartimento debajo del sofá

Open compartment to locate upholstery legs and assembly instructions
Habr  el compartimento para localizara las patas del sof  y las instrucciones de asamblea