



# KIT-STARK DARK GREY SOFA W/ REVERSIBLE CHAISE & 2 LIGHT GREY SWIVEL CHAIRS 313082

*Assembly instructions:*

**PARTS LIST**

No.	DESCRIPTION	IMAGE	Q'TY
A	SOFA SEAT		1
B	CHAISE OTTOMAN SEAT		1
C	REVESIBLE CHAISE SEAT CUSHION		1
D	BACK CUSHION		3
E	PILLOW		2
F	SEAT CUSHION		2
G	LEG		9

**NOTE:** PO # is located underneath/ at the back side of each item. Please be prepared to provide this # should any claim be necessary.

**CAUTION:** Item is heavy. Assembly should be performed by two people.

**1**

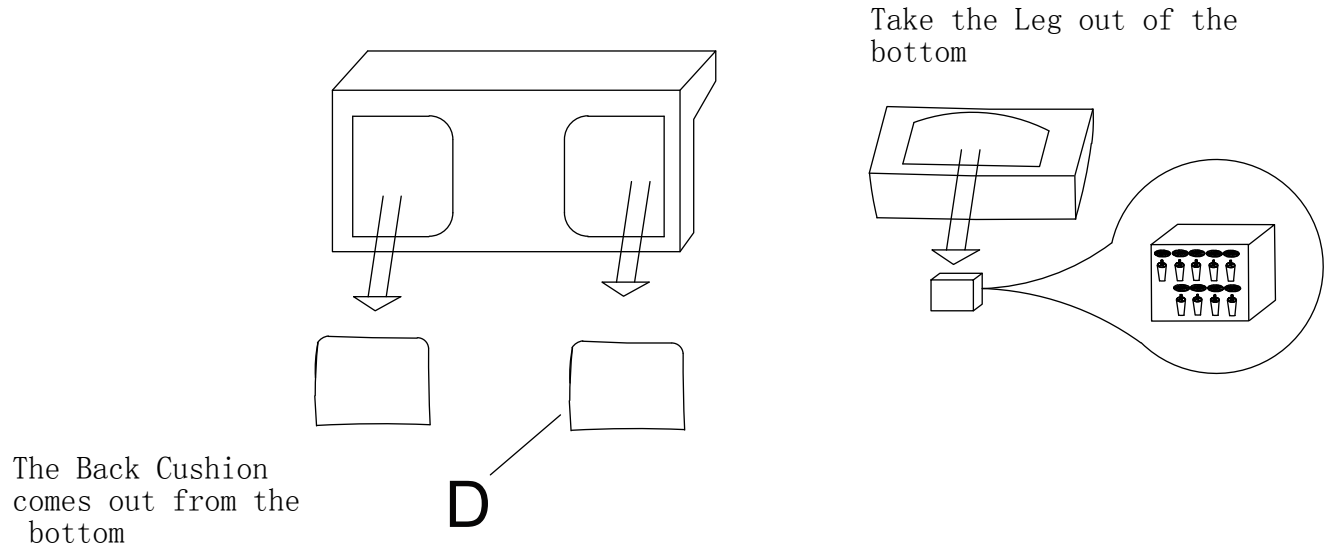

**2**

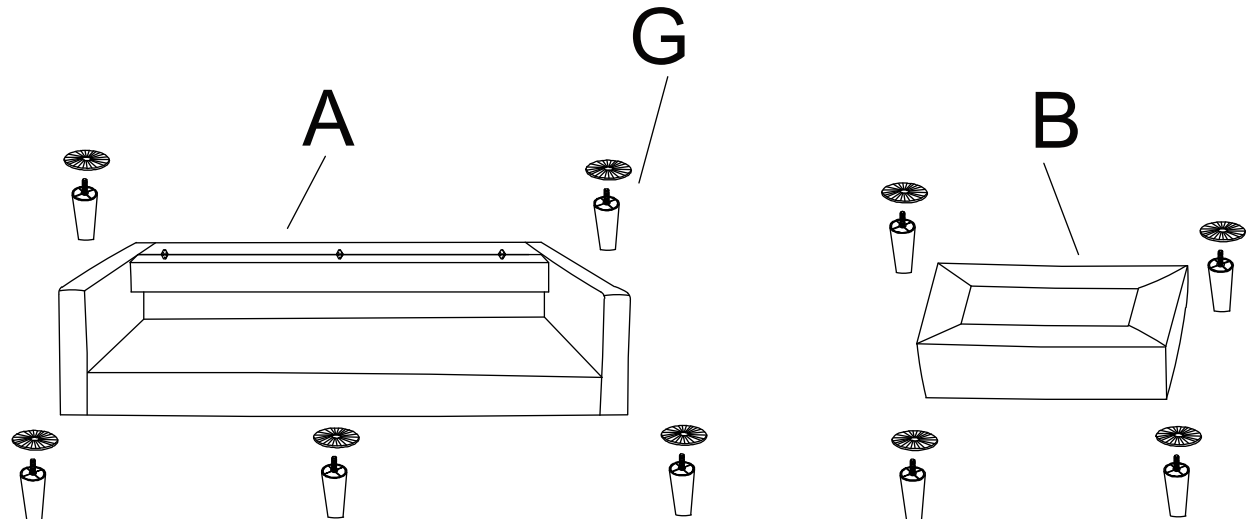

**ASSEMBLED COMPLETED**

# KIT-STARK DARK GREY SOFA W/ REVERSIBLE CHAISE & 2 LIGHT GREY SWIVEL CHAIRS

## 313082

*Assembly instructions:*

**PARTS LIST**

No.	DESCRIPTION	IMAGE	Q'TY
A	SOFA SEAT		1
B	CHAISE OTTOMAN SEAT		1
C	REVESIBLE CHAISE SEAT CUSHION		1
D	BACK CUSHION		3
E	PILLOW		2
F	SEAT CUSHION		2
G	LEG		9

**NOTE:** PO # is located underneath/ at the back side of each item. Please be prepared to provide this # should any claim be necessary.

**CAUTION:** Item is heavy. Assembly should be performed by two people.

3

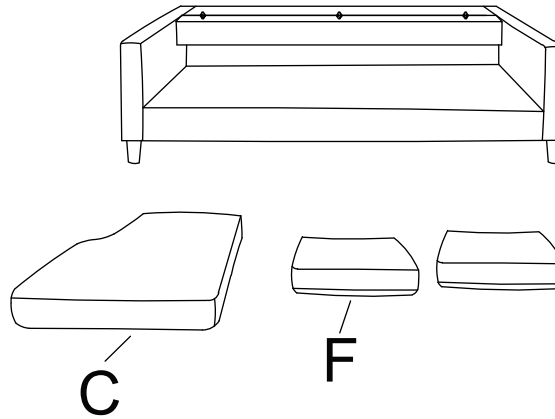

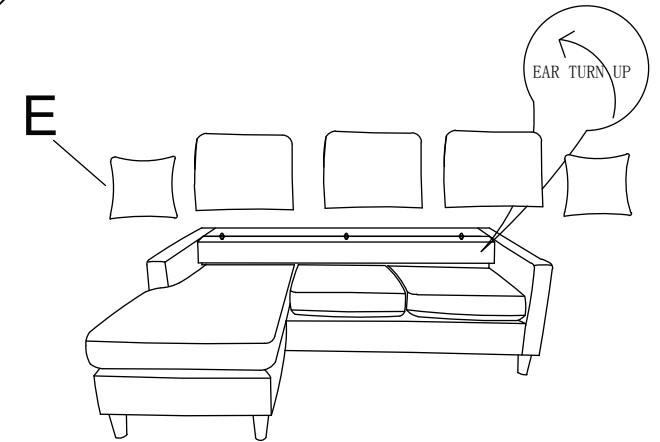

4

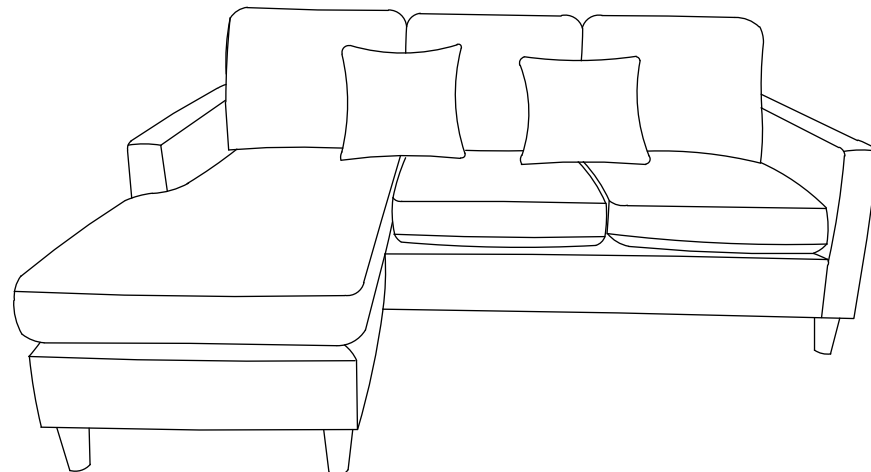

5

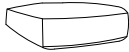

**PARTS LIST**

No.	DESCRIPTION	IMAGE	Q'TY
A	BACK		1
B	SEAT CUSHION		1
C	SEAT		1

**NOTE:** PO # is located underneath/ at the back side of each item. Please be prepared to provide this # should any claim be necessary.

**CAUTION:** Item is heavy. Assembly should be performed by two people.

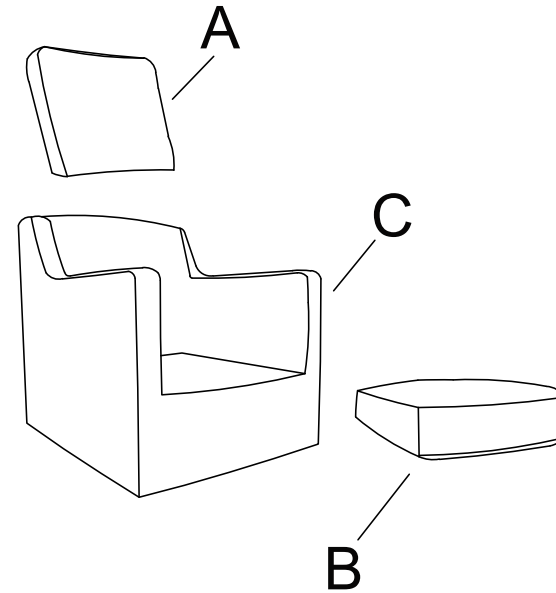

1

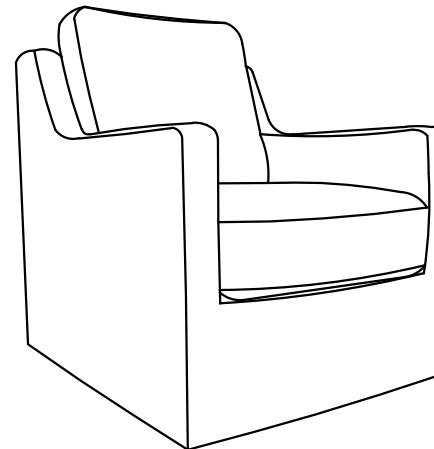

2

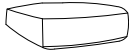

**PARTS LIST**

No.	DESCRIPTION	IMAGE	Q'TY
A	BACK		1
B	SEAT CUSHION		1
C	SEAT		1

**NOTE:** PO # is located underneath/ at the back side of each item. Please be prepared to provide this # should any claim be necessary.

**CAUTION:** Item is heavy. Assembly should be performed by two people.

1

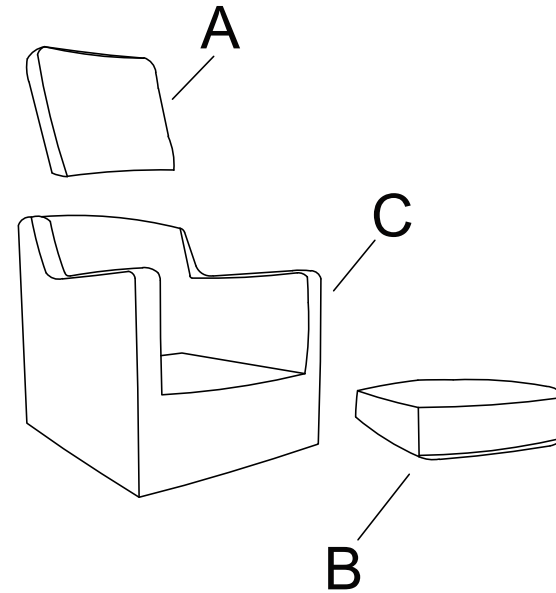

2

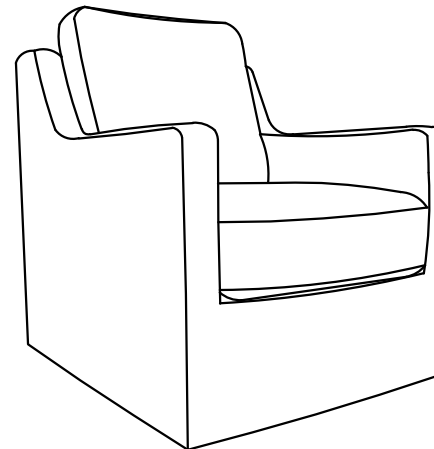

# How to Find Your Furniture Legs

## Cómo encontrar las patas de su mueble

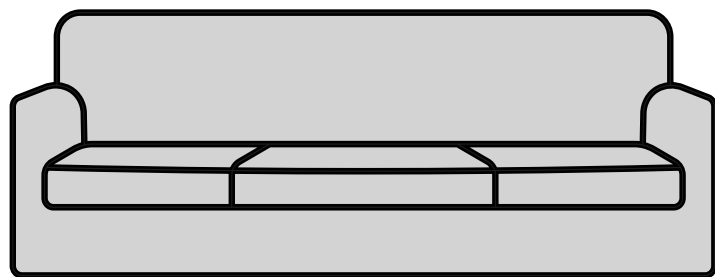

Gently lay sofa/love seat on it's back  
*Coloque suavemente el sofá o el sofá de dos plazas sobre su respaldo*

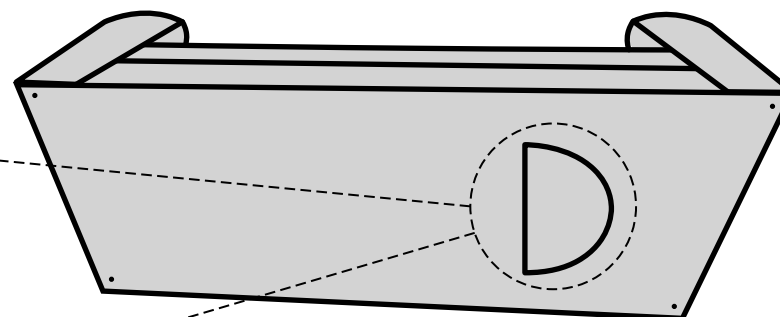
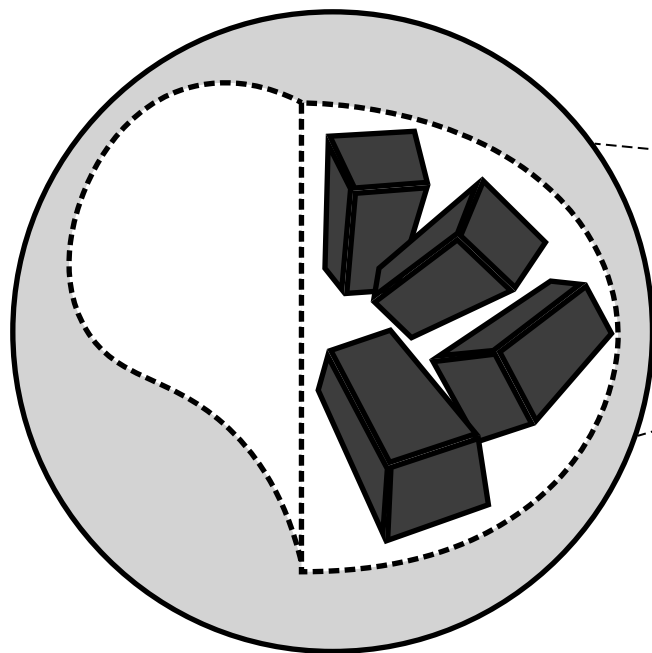

Locate the compartment underneath sofa/love seat  
*Encuentre el compartimento debajo del sofá*

Open compartment to locate upholstery legs and assembly instructions  
*Habr  el compartimento para localizara las patas del sof  y las instrucciones de asamblea*