

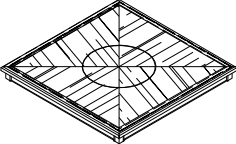

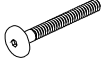
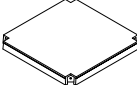

**ASSEMBLY INSTRUCTIONS**  
**INSTRUCCIONES**

**2731T-4848 (COUNTER HIGH TABLE)**  
**2731T-4848 (MESA ALTA DE MOSTRADOR)**

**PARTS LIST**  
**LISTA DE PARTES**

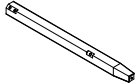
<b>1</b>		1PC / PIEZA	<b>A</b>		<b>BOLT</b> 5/16"*18*2-1/4"	12PCS / PIEZAS
<b>2</b>		1PC / PIEZA	<b>B</b>		<b>SPRING WASHER</b> 5/16"*12mm	12PCS / PIEZAS
<b>3</b>		4PCS / PIEZAS	<b>C</b>		<b>FLAT WASHER</b> 5/16"*19mm	12PCS / PIEZAS
			<b>D</b>		<b>ALLEN WRENCH</b> 4mm	1PC / PIEZA

**ASSEMBLY INSTRUCTIONS**  
**INSTRUCCIONES**

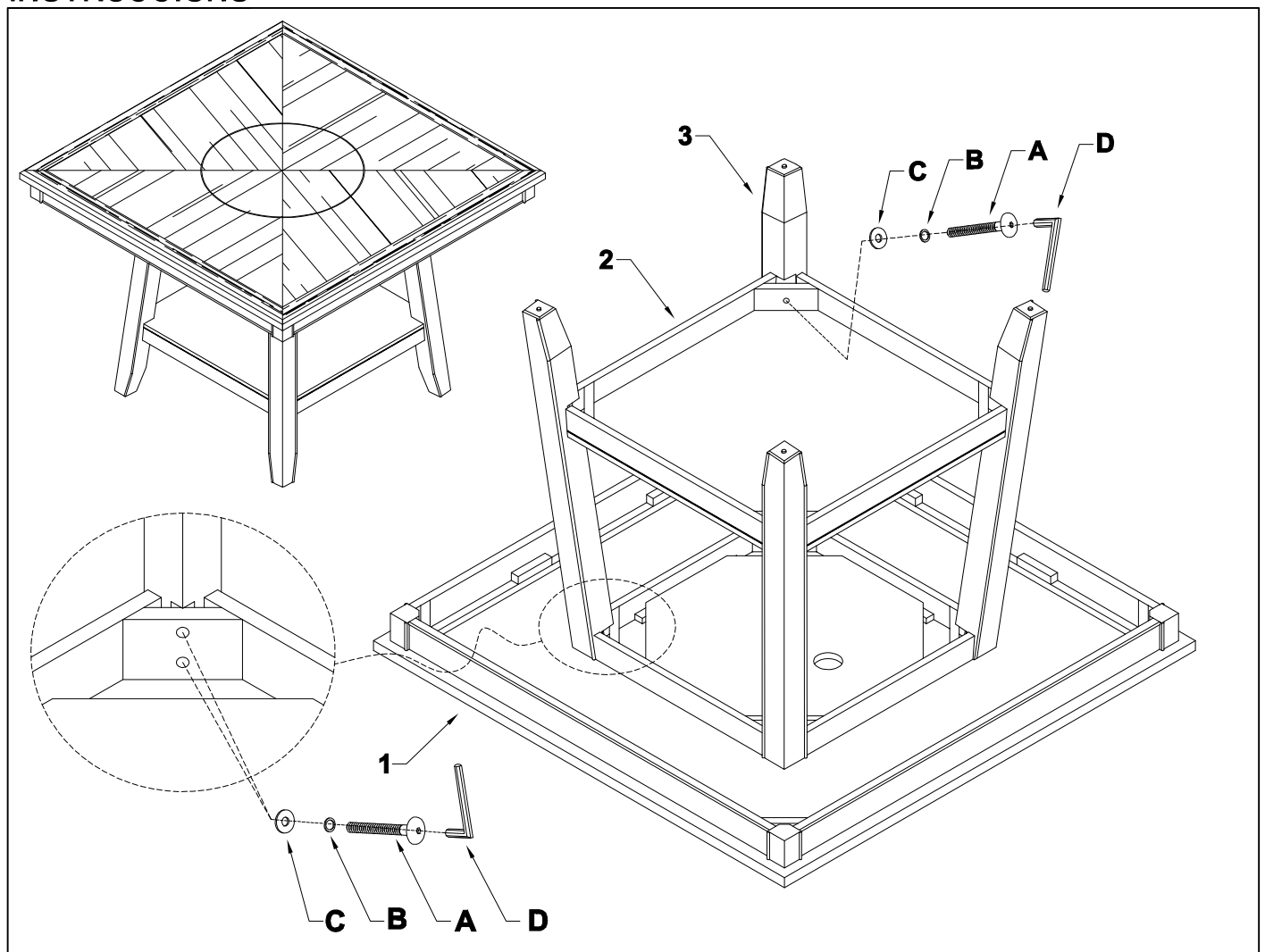

**DO NOT TIGHTEN ALL BOLTS UNTIL COMPLETELY ASSEMBLED.**  
**NO APRETAR LOS TORNILLOS HASTA ARMAR COMPLETAMENTE.**