

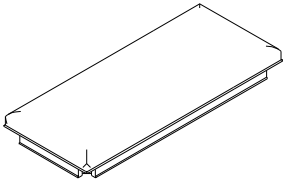

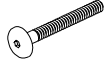

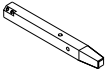

**ASSEMBLY INSTRUCTIONS 2731-BENCH (COUNTER HIGH BENCH)**  
**INSTRUCCIONES 2731-BENCH (BANCA ALTA DE MOSTRADOR)**

**PARTS LIST**  
**LISTA DE PARTES**

<b>1</b>		1PC / PIEZA	<b>A</b>		BOLT 5/16"*18*2"	8PCS / PIEZAS
<b>2</b>		4PCS / PIEZAS L=2PCS / PIEZAS R=2PCS / PIEZAS	<b>B</b>		SPRING WASHER 5/16"*12mm	8PCS / PIEZAS
<b>3</b>		2PCS / PIEZAS	<b>C</b>		FLAT WASHER 5/16"*19mm	8PCS / PIEZAS
<b>4</b>		2PCS / PIEZAS	<b>D</b>		SCREW 1-1/2"	8PCS / PIEZAS
			<b>E</b>		ALLEN WRENCH 4mm	1PC / PIEZA

**ASSEMBLY INSTRUCTIONS**  
**INSTRUCCIONES**

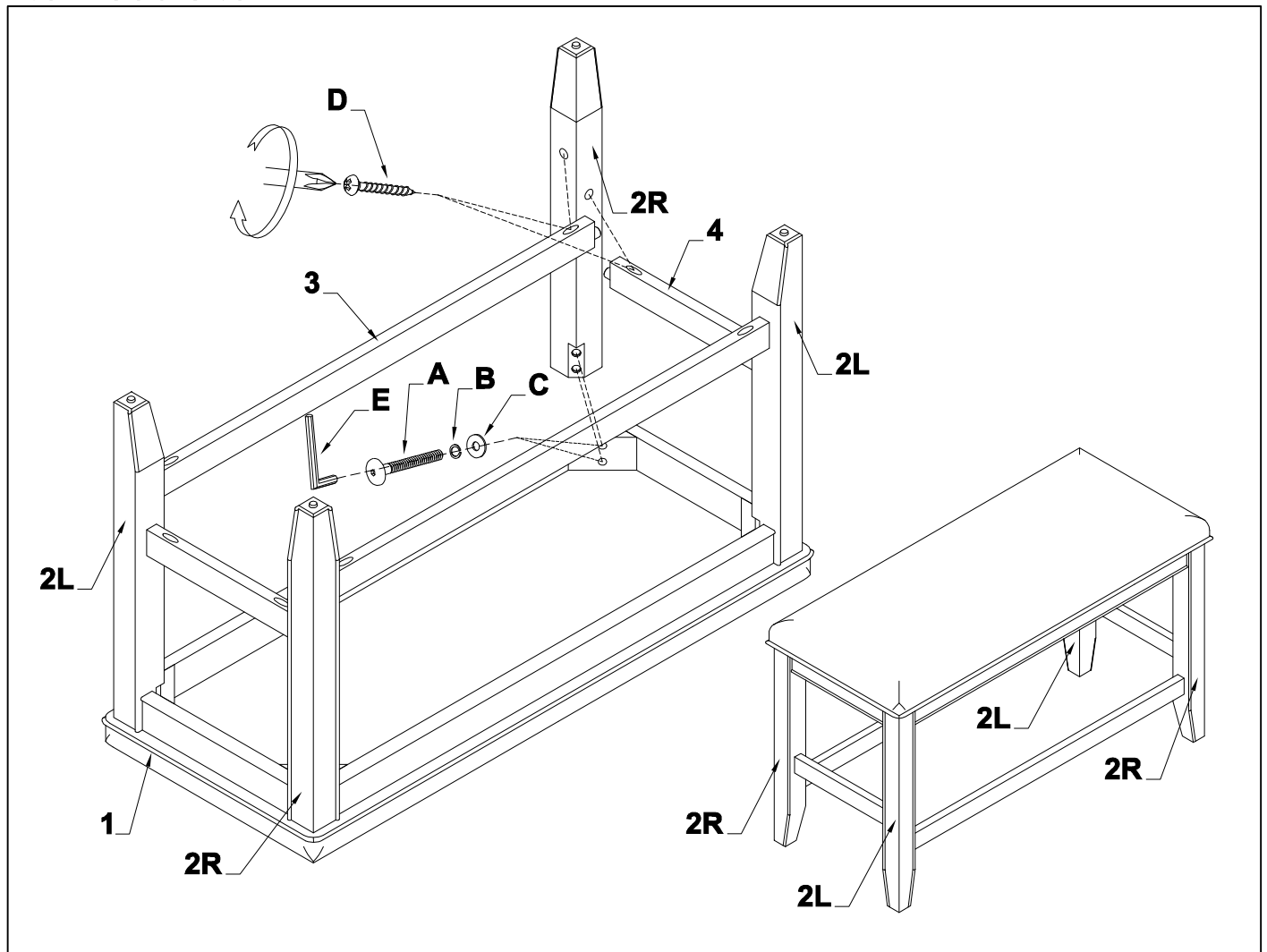

**DO NOT TIGHTEN ALL BOLTS UNTIL COMPLETELY ASSEMBLED.**  
**NO APRETAR LOS TORNILLOS HASTA ARMAR COMPLETAMENTE.**