





LIVING SPACES

CAPRI OUTDOOR SWIVEL BAR STOOL

11BC060A-W-SV
255378

Assembly Instruction

Parts List:

REF	DESCRIPTION	IMAGE	QTY
A	SEAT		1
B	LEG		1
C	CUSHION		1

Hardware List:



REF	DESCRIPTION	IMAGE	QTY
019	BOLT (M6*20L)		4
004	WASHER (M6, ID Φ 6.5, OD Φ 12)		4
001	ALLEN WRENCH (M6)		1

Diagram:

Step 1



Step 2

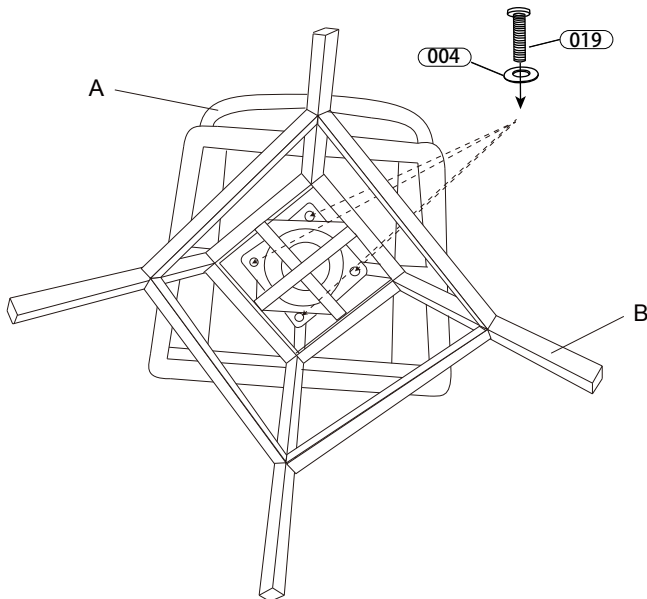
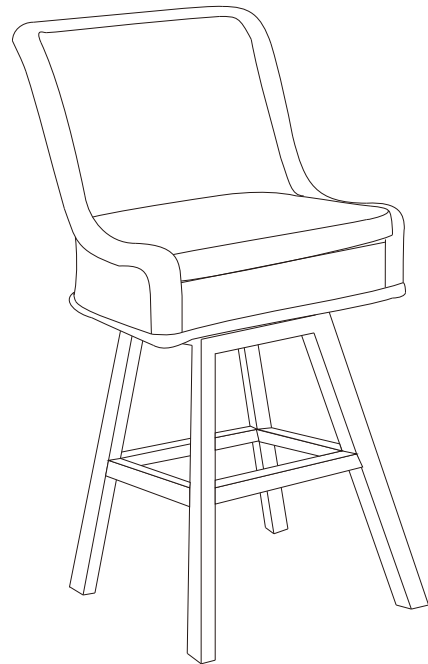

Assembly Steps:

Tip- Remove protective wrapping and lay all parts on floor. Identify all parts packed in Carton against attached parts list to make sure all parts are presented.

Step 1: Place a protective soft material on floor. Lay seat (A) upside down on floor, the bottom is facing up. Then attach leg (B) to the bottom as shown in diagram, using bolt (019) and washer (004).

Step 2: After all bolts are aligned properly before tightening. With a second person's assistance carefully turn the chair over onto its legs. Make sure legs rest on a flat surface. Put the seat cushion on the sofa.

NOTE: IT IS USER'S RESPONSIBILITY TO MAKE SURE ALL PARTS ARE ASSEMBLED AND TIGHTENED PROPERLY AND SECURELY.