

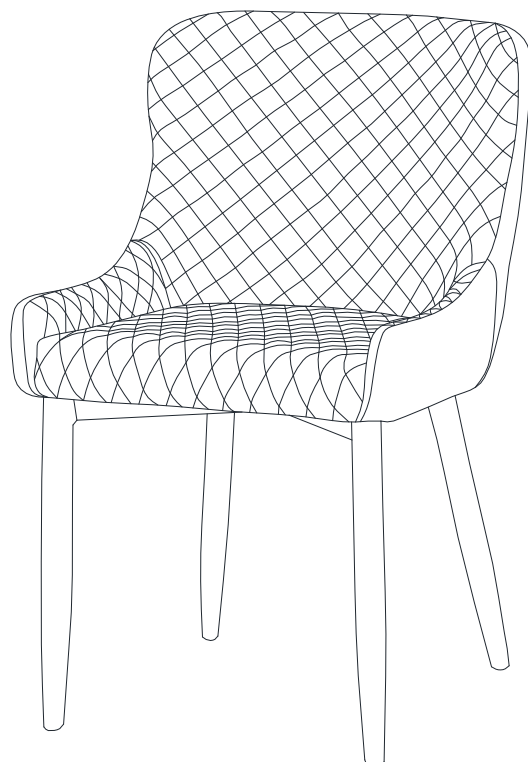

T O V

Draco Grey Chair





Assembly Instructions



Parts List

Label	Picture	Description	QTY
A		Seat	1
B		Chair Legs	1

Hardware

Label	Picture	Description	QTY
F		Bolt	4
G		Flat Washer	4
H		Thick Washer	4
I		Allen Key	1

Assembly Preparation

Before Beginning Assembly:



- Read instructions, cover to cover-



- Have 2 adults on hand for assembly-



- Do not assemble on flooring or carpet-



- Assemble on a clean non-marring surface (packing foam)-



- Save all packaging until finished-

Assembly Steps

Step 1

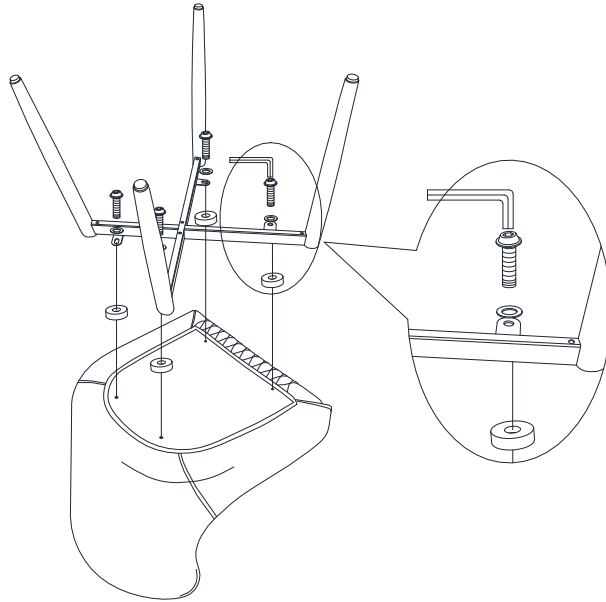





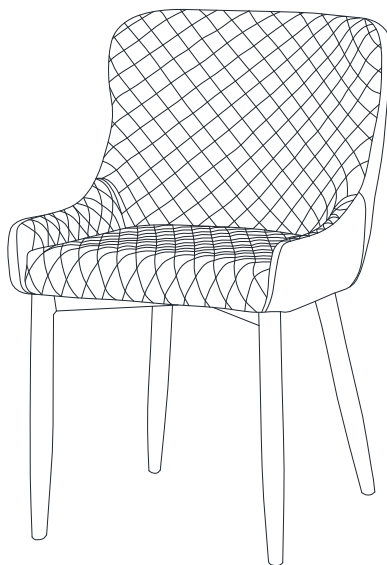



Place the seat faced down as shown
Align the holes of the leg frame and seat and attach with provided hardware.

Step 2



Care & Maintenance

-  • Do not put hot items directly on furniture surface.
-  • Do not clean furniture with harsh cleansers or polish.
-  • Do not place furniture under direct sunlight.
-  • Do not place furniture near heating or cooling vents.
-  • Do not write on furniture without a padded barrier to protect the surface.
-  • Do not place furniture outside. For indoor use only.
-  • Not for commercial use. For residential use only.
-  • Stains may be removed with mild soap solution and damp cloth.

-
-  • Dust and pick-up spills using a clean, non-colored, lint-free cloth.