

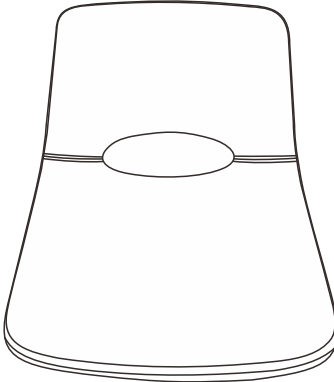

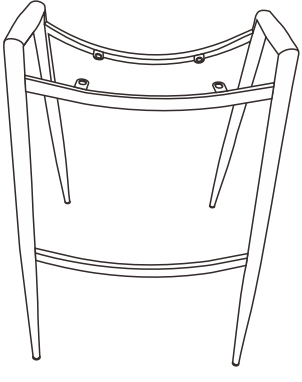







**ITEM NAME /NOM D'ITEM:DESI BAR CHAIR**

**ITEM # /NO. ITEM:101697 (BLACK/NOIR)**

Enquiry:parts@zuomod.com

## **PART LIST/Liste des pièces**

(1)	(2)	(3)												
		<table><tr><td>1.</td><td></td><td>X4</td><td>M6*20mm</td></tr><tr><td>2.</td><td></td><td>X4</td><td></td></tr><tr><td>3.</td><td></td><td>X1</td><td></td></tr></table>	1.		X4	M6*20mm	2.		X4		3.		X1	
1.		X4	M6*20mm											
2.		X4												
3.		X1												

## **INSTRUCTION**

