

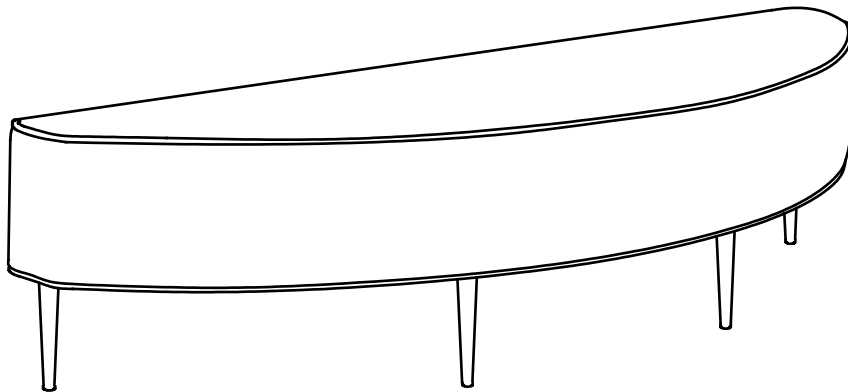

Bianca Bench

Bianca Bench



Assembly Instructions



PARTS LIST

LABEL	PICTURE	DESCRIPTION	QTY
A		Bench	1
B		Leg	4

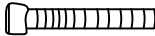
HARDWARE

LABEL	PICTURE	DESCRIPTION	QTY
a		Metal Gasket	12
b		Screw M6x30	12
c		Wrench	1

BEFORE BEGINNING ASSEMBLY:



Read instructions cover to cover



Have two adults on hand for assembly



Do NOT assemble on flooring or carpet. Assemble on a clean non-marring surface (ex: packing foam)



Save all packaging until assembly is completed

ASSEMBLY STEPS

STEP 1

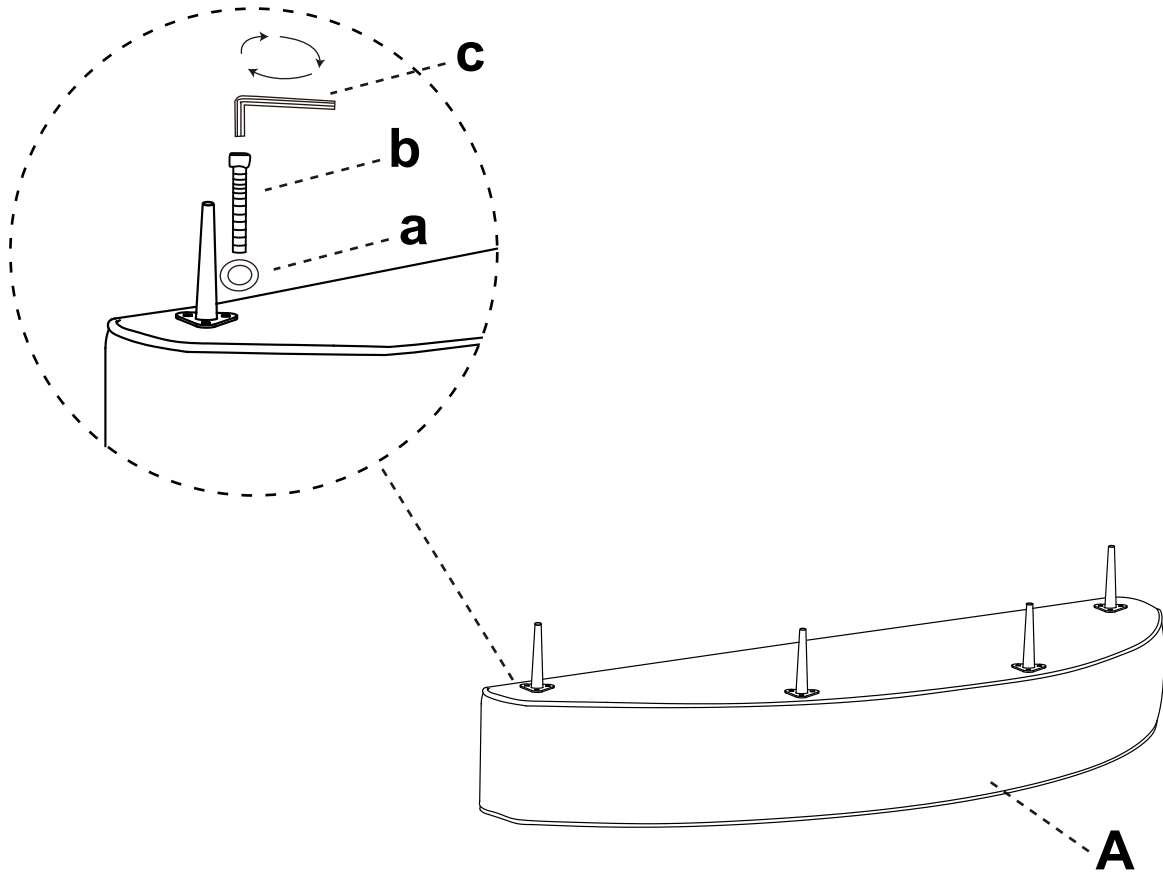

- > Open the compartment on the underside of the bench and remove the legs.
- > Use the included hardware to install the legs as shown.

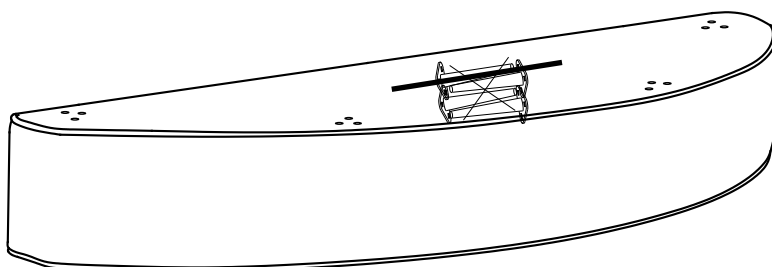

CARE & MAINTENANCE



Do not put hot items directly on furniture surface.



Do not clean furniture with harsh cleansers or polish.



Dust and wipe up spills using a clean, non-colored, lint-free cloth.



Stains may be removed with mild soap solution and a damp cloth



Do not place furniture under direct sunlight.



Do not place furniture near heating or cooling vents.



Do not write on furniture without a padded barrier to protect the surface.



Do not place furniture outside, for indoor use only.