

MADISON PARK® ASSEMBLY INSTRUCTIONS

Description: Glenwood Swivel Counter Stool



Important safety instructions:

- Please read carefully all instructions before assembly.
- For your safety and ease, assembly by two or more adults is recommended.
- Keep instructions for future use.

Pre-assembly:



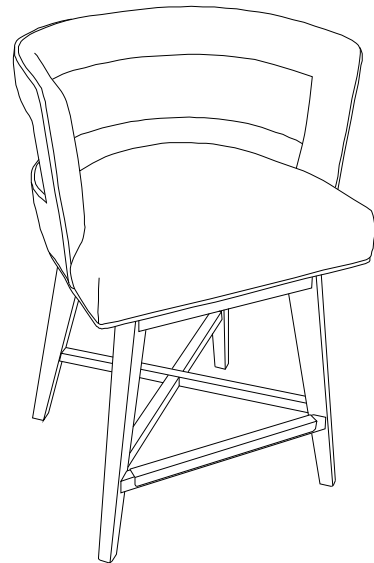

- Do not discard any content until assembly is complete to avoid accidentally discarding small parts or hardware.
- Take out all parts and hardware from box.

Parts List

Item	Description	QTY
P1	Chair Top 	1
P2	Chair Base 	1



Hardware List

Item	Description	QTY
H1	Bolts Ø1/4"*1"L 	8
H2	Lock Washers 1/4" 	8
H3	Flat Washers 1/4" 	8
H4	Allen Wrench 1/4" 	1
H5	Swivel 180° 	1

DISCLAIMER:

WHEN PROPERLY ASSEMBLED, THIS ITEM IS SAFE FOR INTENDED USE. SELLER IS NOT LIABLE FOR ANY DAMAGES RESULTING FROM ITEM BEING IMPROPERLY ASSEMBLED AFTER PURCHASE.

Assembly Procedures:

Step 1. Assemble the stool on a flat, soft surface such as a carpet or cloth to prevent scratching the finish. Loosely attach the swivel (H5) to the top of chair base (P2) as shown below image 1.





- (H1)x4 Bolts Ø1/4"*1"L 
- (H2)x4 Lock Washers 1/4" 
- (H3)x4 Flat Washers 1/4" 
- (H4)x1 Allen Wrench 1/4" 





Image 1

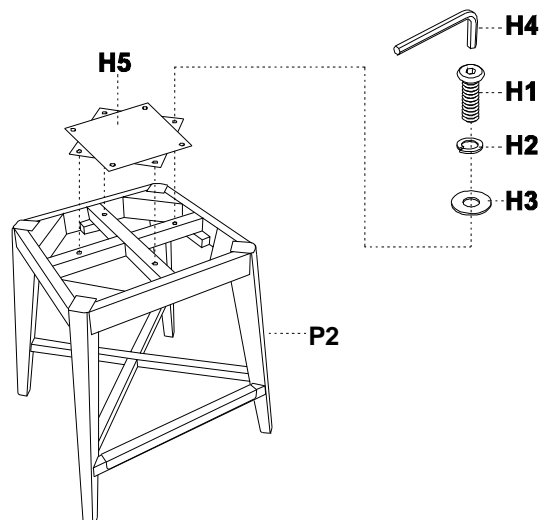

Step 2.

1) Loosely attach the assembled chair base (P2) to the bottom of chair top (P1) to the seat bottom as shown below image 2.

2) Make sure the stool is level and securely tighten all bolts with Allen wrench (H4), see image 2.

- (H1)x4 Bolts $\varnothing 1/4'' \times 1''$ 
- (H2)x4 Lock Washers 1/4" 
- (H3)x4 Flat Washers 1/4" 
- (H4)x1 Allen Wrench 1/4" 

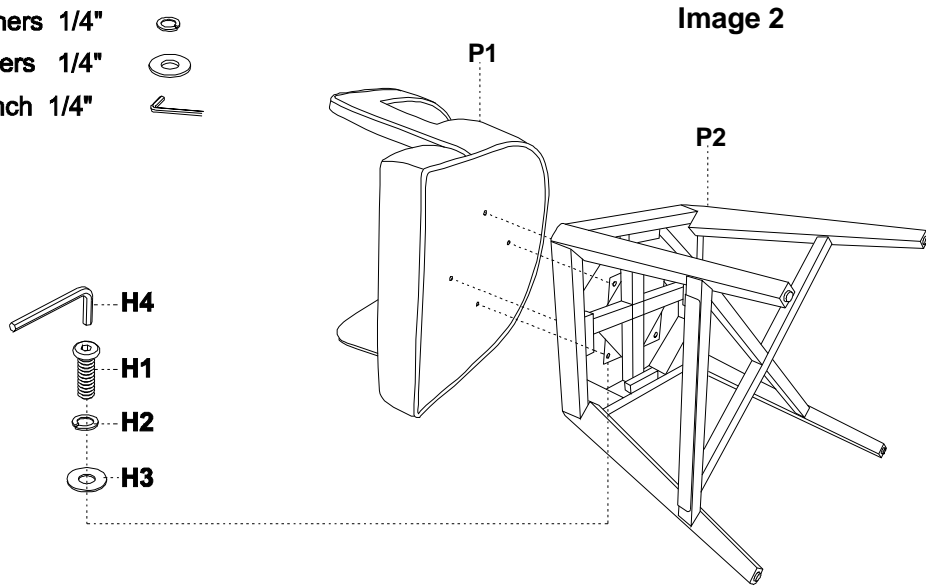

Step 3.

Turn the assembled stool to an upright position, assembly is complete. **Failure to follow these instructions may cause the bolts to misalign during assembly.**

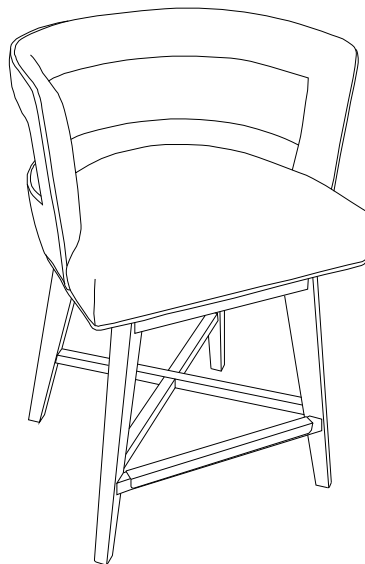

ADDITIONAL NOTE ABOUT SAFETY: BOLTS MAY LOOSEN DURING NORMAL EVERYDAY USE. THEY SHOULD BE PERIODICALLY INSPECTED AND RE-TIGHTENED TO PREVENT DAMAGE OR INJURY. ALWAYS CHECK TO ENSURE THAT ALL HARDWARE IS KEPT TIGHTENED.

Thank you for your purchase