

ASSEMBLY INSTRUCTIONS



GROUP NO.: 5874 HEADBOARD

ITEM NO.: 5874FNV-1 / 5874FTE-1 / 5874FGY-1 FULL HEADBOARD
 5874NV-1 / 5874TE-1 / 5874GY-1 QUEEN HEADBOARD
 5874KNV-1 / 5874KTE-1 / 5874KGY-1 EK / CK HEADBOARD

Thank you for purchasing this product. Please take time to read and follow the instructions below. Check that you have all parts and hardware before assembly. Parts apparently missing are often found in the packing materials. If you do not have all the parts listed, have your dealer contact us and they be sent to you immediately.

! It is recommended to install protective pads under all legs and supports to avoid damage or scratches when placing furniture on a wood floor or other hard surface, and to limit indentation and prevent discoloration if placing on carpet.

PARTS LIST				HARDWARE LIST				
NO.	DESCRIPTION	SKETCH	QTY	NO.	DESCRIPTION	SKETCH	SIZE	QTY
A	Headboard		1 PC	1	Flat Washer		Ø5/16**19m	6 PCS
B	HB Leg - L		1 PC	2	Spring Washer		Ø5/16"	6 PCS
C	HB Leg - R		1 PC	3	Bolt		Ø5/16**45mm	6 PCS
				4	Allen Key		4mm*60mm	1 PC

STEP 1: Attach Legs L/R (B),(C) to Headboard (A) using Allen bolts (3), Spring washer (2), Flat washer (1), by Allen Key (4).

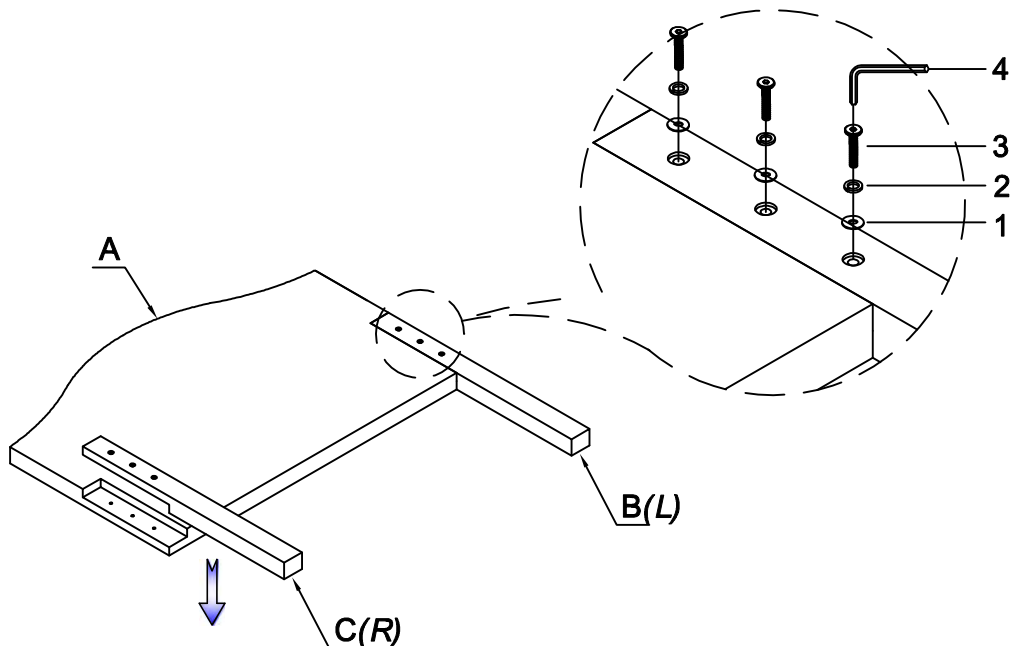







ASSEMBLY INSTRUCTIONS







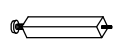

GROUP NO.: 5874 QUEEN / FULL BED

ITEM NO.: 5874NV-1 / 5874TE-1 / 5874GY-1 QUEEN HEADBOARD
 5874NV-3 / 5874TE-3 / 5874GY-3 QUEEN FOOTBOARD & SIDERAILS, SLATS
 5874FNV-1 / 5874FTE-1 / 5874FGY-1 FULL HEADBOARD
 5874FNV-3 / 5874FTE-3 / 5874FGY-3 FULL FOOTBOARD & SIDERAILS, SLATS

Thank you for purchasing this product. Please take time to read and follow the instructions below. Check that you have all parts and hardware before assembly. Parts apparently missing are often found in the packing materials. If you do not have all the parts listed, have your dealer contact us and they be sent to you immediately.

! It is recommended to install protective pads under all legs and supports to avoid damage or scratches when placing furniture on a wood floor or other hard surface, and to limit indentation and prevent discoloration if placing on carpet.

PARTS LIST			
NO.	DESCRIPTION	SKETCH	QTY
A	Headboard		1 PC
B	Footboard		1 PC
C	Side rail		2 PCS
D	Bed Slat		4 PCS
E	Slats support legs		4 PCS
F	Bun Foot - L		1 PC
G	Bun Foot - R		1 PC

HARDWARE LIST				
NO.	DESCRIPTION	SKETCH	SIZE	QTY
1	Flat Washer		Ø5/16**19m	2 PCS
2	Spring Washer		Ø5/16"	2 PCS
3	Bolt		Ø5/16**75mm	2 PCS
4	Allen Key		4mm*100mm	1 PC
5	Thread Bold		Ø5/16**80mm	8 PCS
6	Curve Washer			8 PCS
7	Hexagonal Nut			8 PCS
8	Wrench			1 PC
9	Screw		M4 x 30mm	16 PCS

* ABOVE HARDWARE ARE PACKED IN BOX-3 FOR ASSEMBLY

STEP 1: Attach Bun foot L/R (F),(G) to Footboard (B) using Allen bolts (3), Spring washer (2), Flat washer (1), by Allen Key (4).

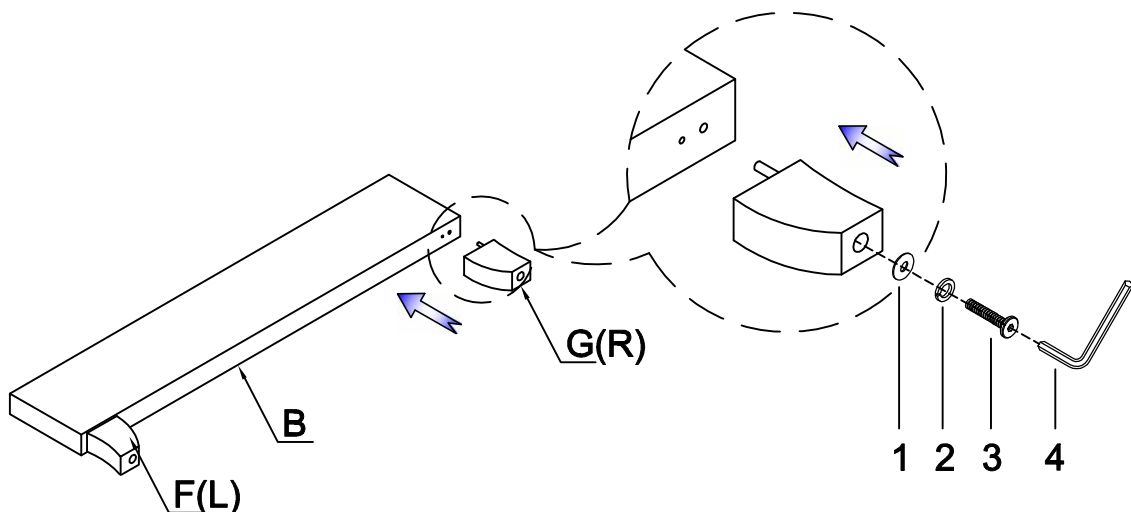



ASSEMBLY INSTRUCTIONS

GROUP NO.: 5874 QUEEN / FULL BED

ITEM NO.: 5874NV-1 / 5874TE-1 / 5874GY-1 QUEEN HEADBOARD
5874NV-3 / 5874TE-3 / 5874GY-3 QUEEN FOOTBOARD & SIDERAILS, SLATS
5874FNV-1 / 5874FTE-1 / 5874FGY-1 FULL HEADBOARD
5874FNV-3 / 5874FTE-3 / 5874FGY-3 FULL FOOTBOARD & SIDERAILS, SLATS

STEP 2: Attach Side rail (C) to Headboard (A) & Footboard (B) using Thread bolts (5), Curve washer (6), Hexagonal nut (7) by Wrench (8).

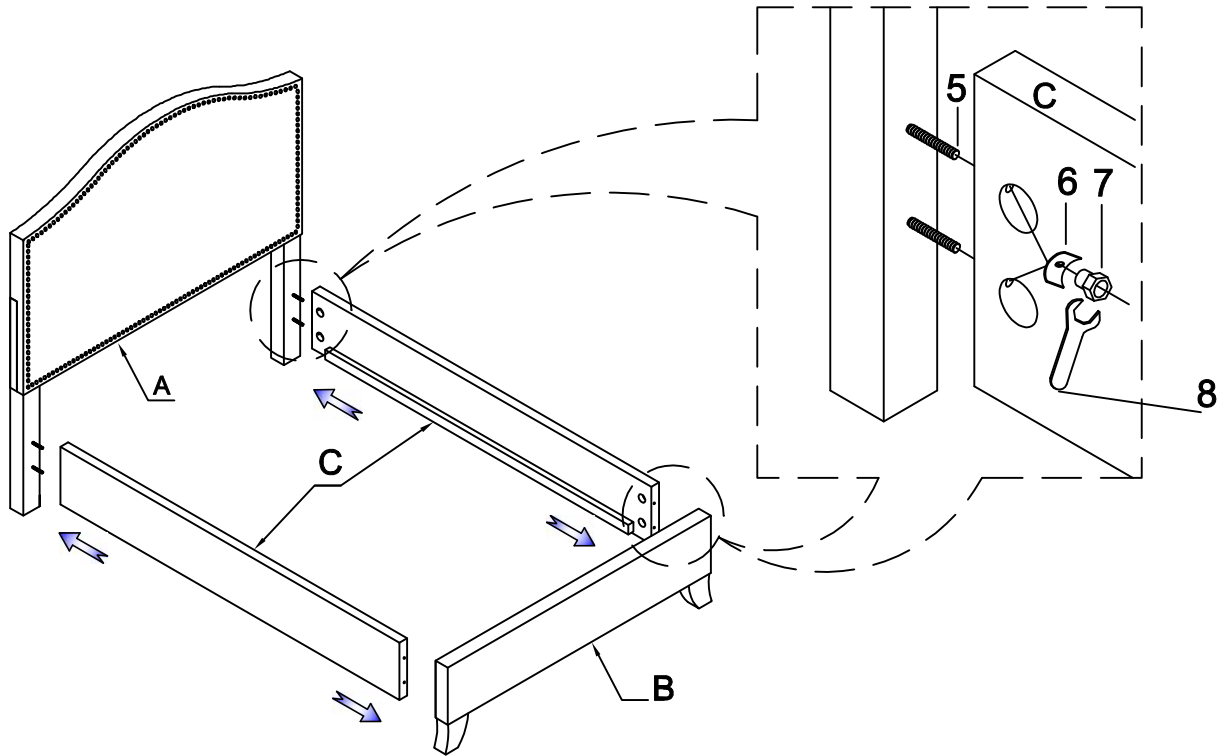

STEP 3: Attach Slat support legs (E) to Slat (D).

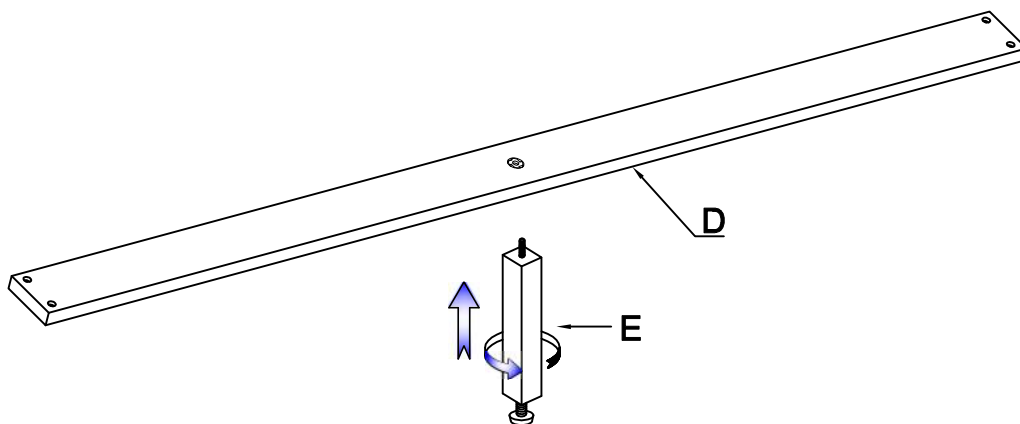

ASSEMBLY INSTRUCTIONS



GROUP NO.: 5874 QUEEN / FULL BED

ITEM NO.: 5874NV-1 / 5874TE-1 / 5874GY-1 QUEEN HEADBOARD

5874NV-3 / 5874TE-3 / 5874GY-3 QUEEN FOOTBOARD & SIDERAILS, SLATS

5874FNV-1 / 5874FTE-1 / 5874FGY-1 FULL HEADBOARD

5874FNV-3 / 5874FTE-3 / 5874FGY-3 FULL FOOTBOARD & SIDERAILS, SLATS

STEP 4: Attached slat (D) to bed side rail (C) by using screw (9).

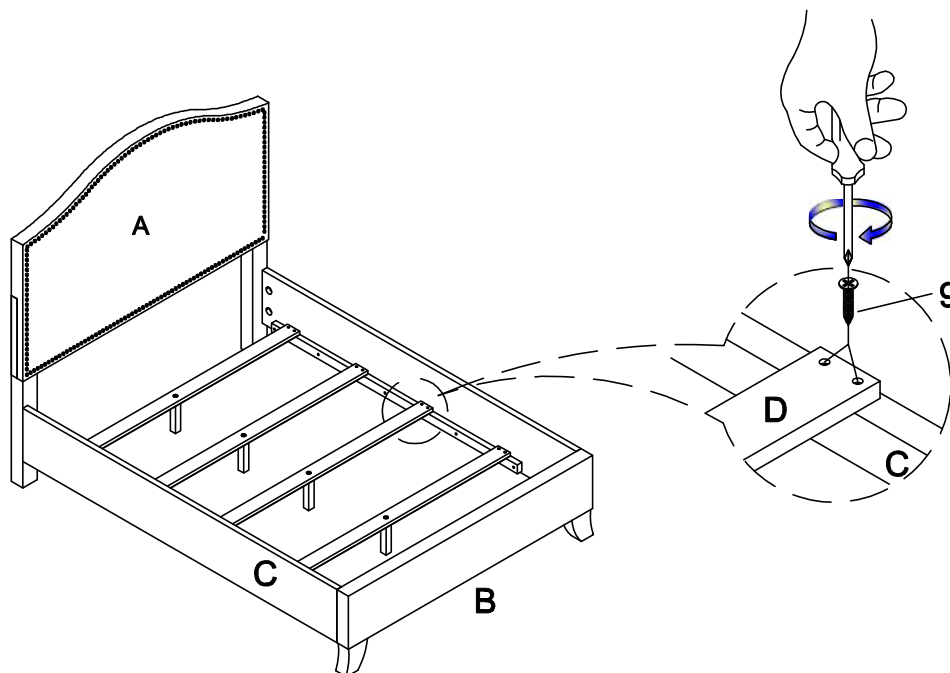

COMPLETED

