



# ASSEMBLY INSTRUCTIONS

**GROUP NO.: 5874 HEADBOARD**

ITEM NO.: 5874FNV-1 / 5874FTE-1 / 5874FGY-1 FULL HEADBOARD  
 5874NV-1 / 5874TE-1 / 5874GY-1 QUEEN HEADBOARD  
 5874KNV-1 / 5874KTE-1 / 5874KGY-1 EK / CK HEADBOARD

Thank you for purchasing this product. Please take time to read and follow the instructions below. Check that you have all parts and hardware before assembly. Parts apparently missing are often found in the packing materials. If you do not have all the parts listed, have your dealer contact us and they be sent to you immediately.

**!** It is recommended to install protective pads under all legs and supports to avoid damage or scratches when placing furniture on a wood floor or other hard surface, and to limit indentation and prevent discoloration if placing on carpet.

PARTS LIST				HARDWARE LIST				
NO.	DESCRIPTION	SKETCH	QTY	NO.	DESCRIPTION	SKETCH	SIZE	QTY
A	Headboard		1 PC	1	Flat Washer		Ø5/16**19m	6 PCS
B	HB Leg - L		1 PC	2	Spring Washer		Ø5/16"	6 PCS
C	HB Leg - R		1 PC	3	Bolt		Ø5/16**45mm	6 PCS
				4	Allen Key		4mm*60mm	1 PC

**STEP 1:** Attach Legs L/R (B),(C) to Headboard (A) using Allen bolts (3), Spring washer (2), Flat washer (1), by Allen Key (4).

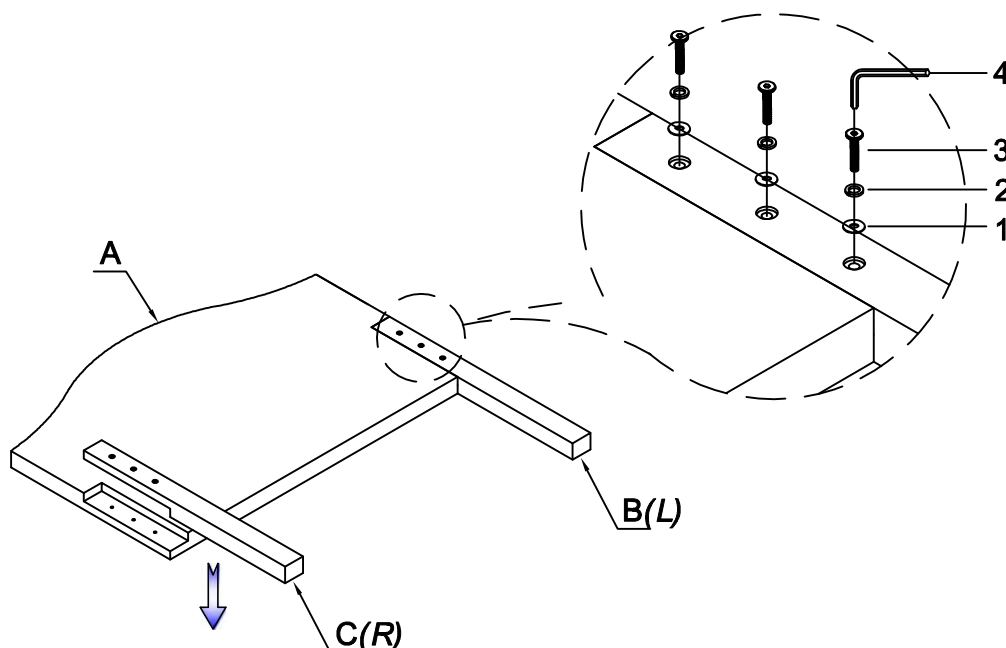







# ASSEMBLY INSTRUCTIONS







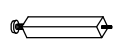

## GROUP NO.: 5874 QUEEN / FULL BED

ITEM NO.: 5874NV-1 / 5874TE-1 / 5874GY-1 QUEEN HEADBOARD  
 5874NV-3 / 5874TE-3 / 5874GY-3 QUEEN FOOTBOARD & SIDERAILS, SLATS  
 5874FNV-1 / 5874FTE-1 / 5874FGY-1 FULL HEADBOARD  
 5874FNV-3 / 5874FTE-3 / 5874FGY-3 FULL FOOTBOARD & SIDERAILS, SLATS

Thank you for purchasing this product. Please take time to read and follow the instructions below. Check that you have all parts and hardware before assembly. Parts apparently missing are often found in the packing materials. If you do not have all the parts listed, have your dealer contact us and they be sent to you immediately.

**!** It is recommended to install protective pads under all legs and supports to avoid damage or scratches when placing furniture on a wood floor or other hard surface, and to limit indentation and prevent discoloration if placing on carpet.

PARTS LIST			
NO.	DESCRIPTION	SKETCH	QTY
A	Headboard		1 PC
B	Footboard		1 PC
C	Side rail		2 PCS
D	Bed Slat		4 PCS
E	Slats support legs		4 PCS
F	Bun Foot - L		1 PC
G	Bun Foot - R		1 PC

HARDWARE LIST				
NO.	DESCRIPTION	SKETCH	SIZE	QTY
1	Flat Washer		Ø5/16**19m	2 PCS
2	Spring Washer		Ø5/16"	2 PCS
3	Bolt		Ø5/16**75mm	2 PCS
4	Allen Key		4mm*100mm	1 PC
5	Thread Bold		Ø5/16**80mm	8 PCS
6	Curve Washer			8 PCS
7	Hexagonal Nut			8 PCS
8	Wrench			1 PC
9	Screw		M4 x 30mm	16 PCS

\* ABOVE HARDWARE ARE PACKED IN BOX-3 FOR ASSEMBLY

**STEP 1:** Attach Bun foot L/R (F),(G) to Footboard (B) using Allen bolts (3), Spring washer (2), Flat washer (1), by Allen Key (4).

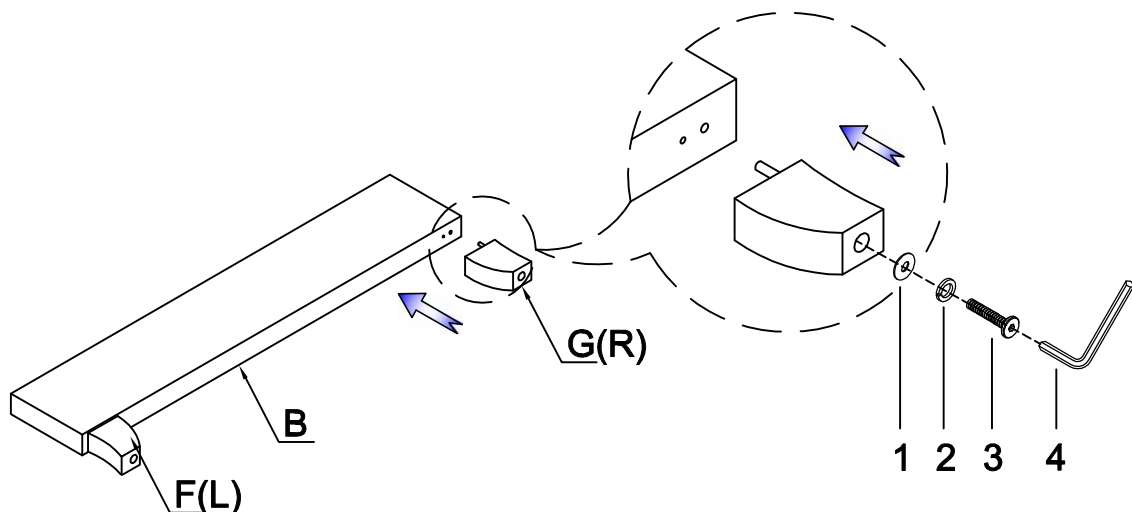

# ASSEMBLY INSTRUCTIONS

## GROUP NO.: 5874 QUEEN / FULL BED

ITEM NO.: 5874NV-1 / 5874TE-1 / 5874GY-1 QUEEN HEADBOARD  
5874NV-3 / 5874TE-3 / 5874GY-3 QUEEN FOOTBOARD & SIDERAILS, SLATS  
5874FNV-1 / 5874FTE-1 / 5874FGY-1 FULL HEADBOARD  
5874FNV-3 / 5874FTE-3 / 5874FGY-3 FULL FOOTBOARD & SIDERAILS, SLATS

**STEP 2:** Attach Side rail (C) to Headboard (A) & Footboard (B) using Thread bolts (5), Curve washer (6), Hexagonal nut (7) by Wrench (8).

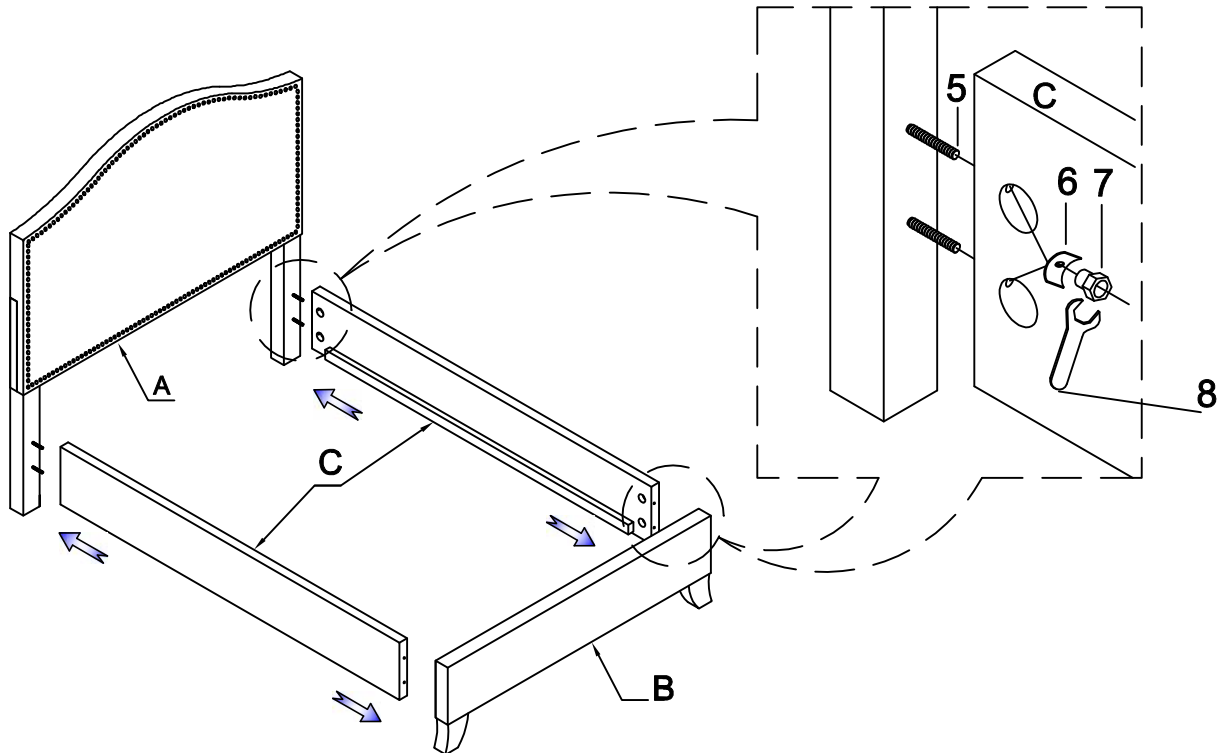

**STEP 3:** Attach Slat support legs (E) to Slat (D).

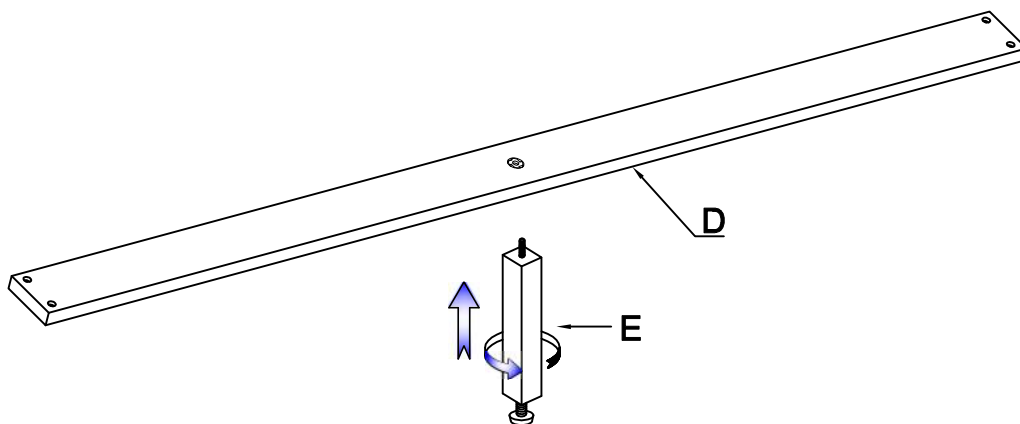

# ASSEMBLY INSTRUCTIONS



**GROUP NO.: 5874 QUEEN / FULL BED**

ITEM NO.: 5874NV-1 / 5874TE-1 / 5874GY-1 QUEEN HEADBOARD

5874NV-3 / 5874TE-3 / 5874GY-3 QUEEN FOOTBOARD & SIDERAILS, SLATS

5874FNV-1 / 5874FTE-1 / 5874FGY-1 FULL HEADBOARD

5874FNV-3 / 5874FTE-3 / 5874FGY-3 FULL FOOTBOARD & SIDERAILS, SLATS

**STEP 4: Attached slat (D) to bed side rail (C) by using screw (9).**

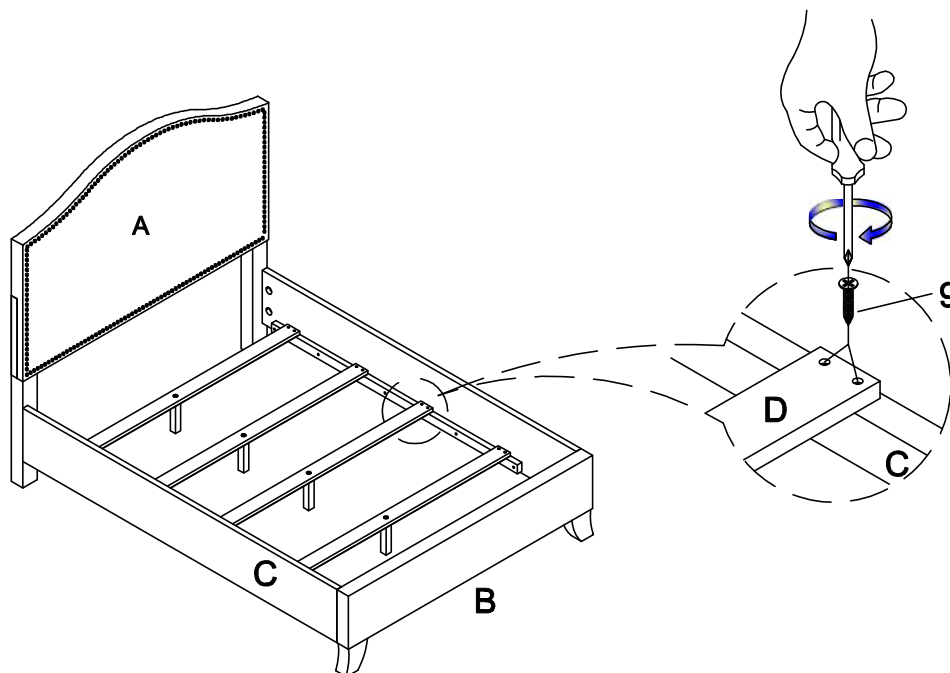

**COMPLETED**

