







LIVING SPACES

A	DM386A-A	 x1
B	DM386A-B	 x1
C	DM386A-C	 x4 M6x20mm
D	DM386A-D	 x4 M6x17x1.2mm
E	DM386A-E	 x1

①

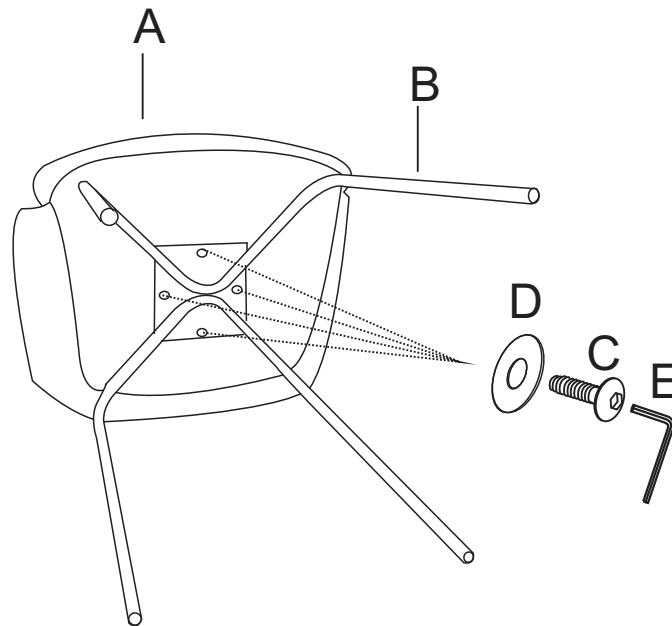

②

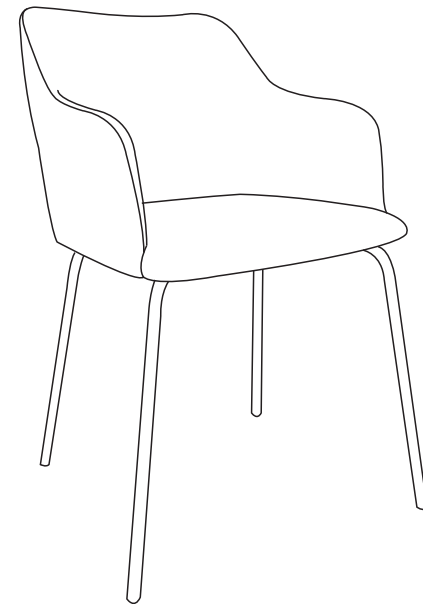

DAVY STATIONARY OFFICE CHAIR

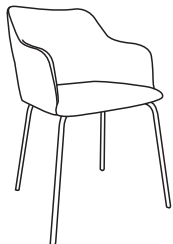

DM386A/301766,301767

