











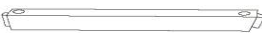

MADISON **PARK**

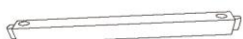
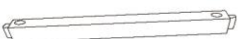
Assembly Instruction--Counterstool

PARTS #	PARTS NAME	DRAWING	QTY
P1	Left front leg		1
P2	Right front leg		1
P3	Left black leg		1
P4	Right black leg		1
P5	Left side footrest		1
P6	Right side footrest		1
P7	Front footrest		1
P8	Black footrest		
P9	Chair		1

HAREWARE#	PARTS NAME	DRAWING	QTY
H1	Bolts $\phi 5/16 \times 2-3/8$ "		9
H2	Lock Washers $\phi 5/16$ "		9
H3	Flat Washers $\phi 5/16$ "		9
H4	Allen Wrench $\phi 5/16$ "		1
H5	Screw		6

Step 1. Take out the legs , footrest and hardware from the box.

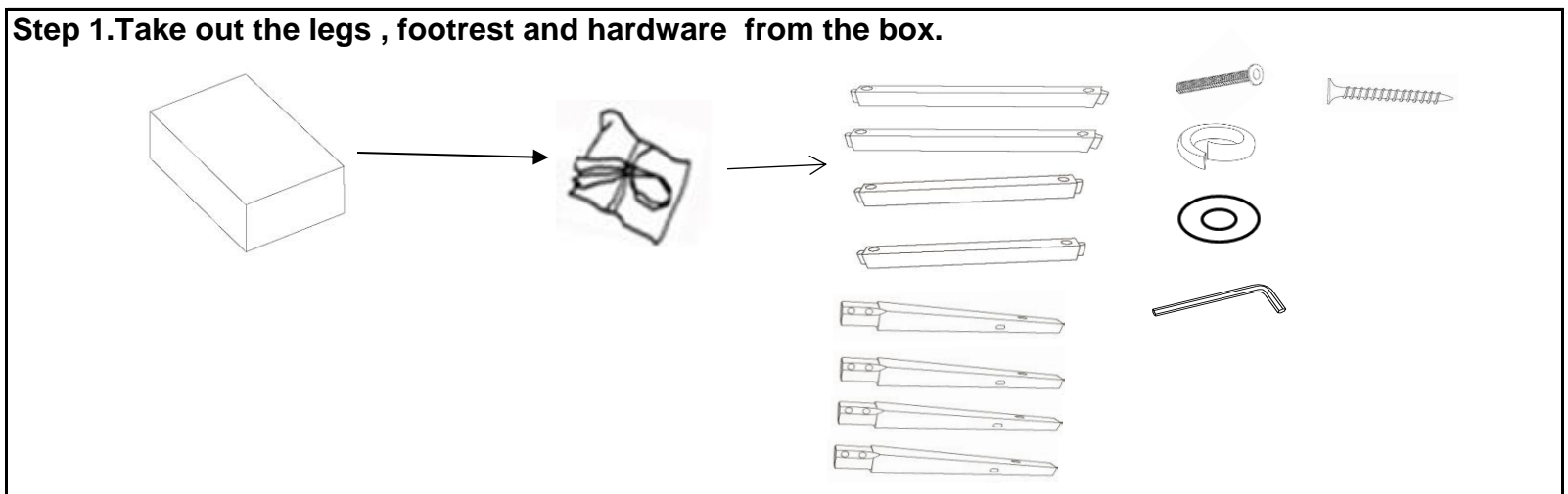

Step 2: Insert left front leg (P1), right front leg (P2) to the Chair (P9) bottom, insert the front footrest (P7) to the front legs (P1)(P2), then lock legs by using spring washer (H2), flat washer (H3), bolt (H1), tighten the bolts with allen wrench (H4). Lock the front footrest by using the screw (H5). After that insert the left side footrest (P5), right side footrest (P6) to the front legs (P1)(P2) by using the screw (H5), last insert the back legs (P3)(P4) to the chair (P9) bottom, insert the back footrest (P8) to the back legs (P3)(P4) lock that by using the screw (H5). And lock the back legs by spring washer (H2), flat washer (H3), bolt (H1), tighten all the bolts with allen wrench (H4).

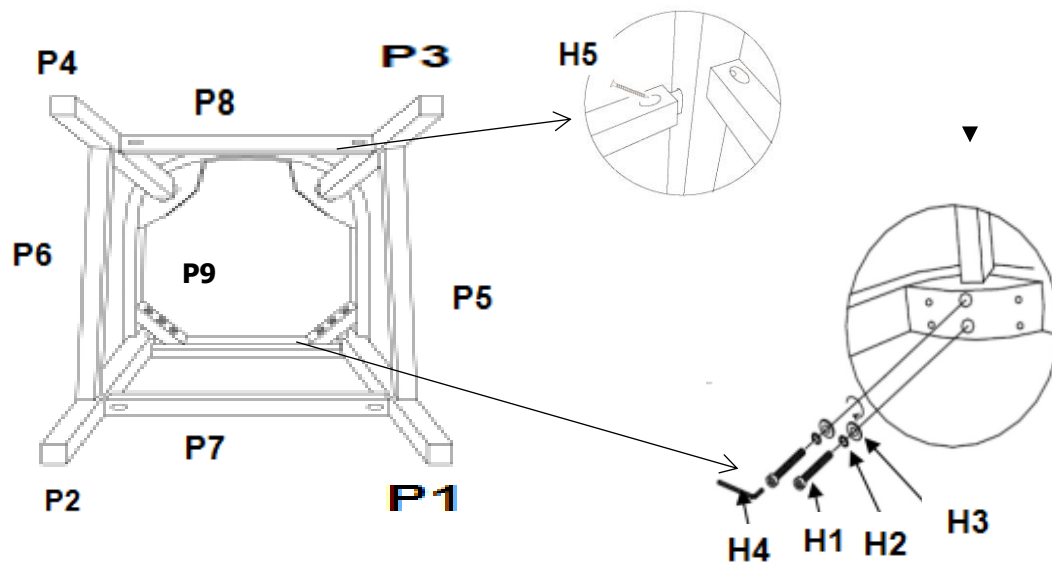

Step 3: Turn the chair over and place it upright on a level surface.

