

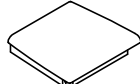

**Read instructions carefully prior to assembly.**

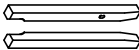



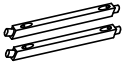

Thank you for purchasing this quality product. Check carefully for small parts which may come loose during shipment. Remove all components from pack and place top down on soft surface such as carpet or cloth to prevent scratching the finish. Identify and count all parts as specified below.

**It is recommended to use two or more people during the assembly process.**

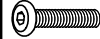
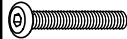
**PARTS LIST FOR 2 CHAIR**

No.	Description	Sketch	Qty
A	Chair Back		2 pcs
B	Seat Cushion Frame		2 pcs
C	L/R Front Leg		4 pcs
D	Front Strecher		2 pcs
E	L/R Side Stretcher		4 pcs

**HARDWARE LIST FOR 2 CHAIR**

No.	Description	Sketch	Size	Qty
1	Short Bolt		φ5/16" x 38mm	4 pcs
2	Medium Bolt		φ5/16" x 50mm	8 pcs
3	Long Bolt		φ5/16" x 75mm	8 pcs
4	Lock Washer		φ5/16"	20 pcs
5	Flat Washer		φ5/16" x 19mm	20 pcs
6	Allen Key		4mm	1 pc
7	Screw		M4 x 38mm	12 pcs

**Step 1:** Place the Chair Back (A) on a piece of cloth or carpet to prevent finish from scratching. Attach Seat Cushion Frame (B) to Chair Back (A) by using Flat Washer (5), Lock Washer (4), Short Bolt (1) on back rail and Long Bolt (3) at the corner of seat frame then secure with Allen Key (6). Do not fully tighten.

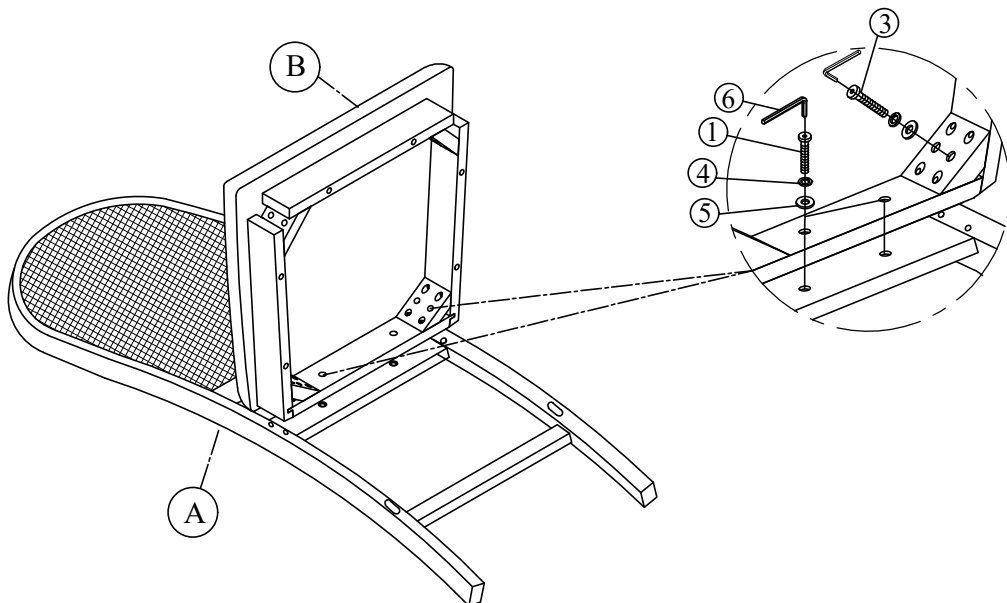

**Step 2:** Attach the Left and Right Front Leg (C) to Seat Cushion Frame (B) by using Flat Washer (5), Lock Washer (4), Medium Bolt (2) and tighten with Allen Key (6). Do not fully tighten. Attach The front stretcher (D) and L/R Side Stretcher (E) to L/R Front Leg (C) with the Screw (7) and secure with Phillips-head screw drivers (Not provided).

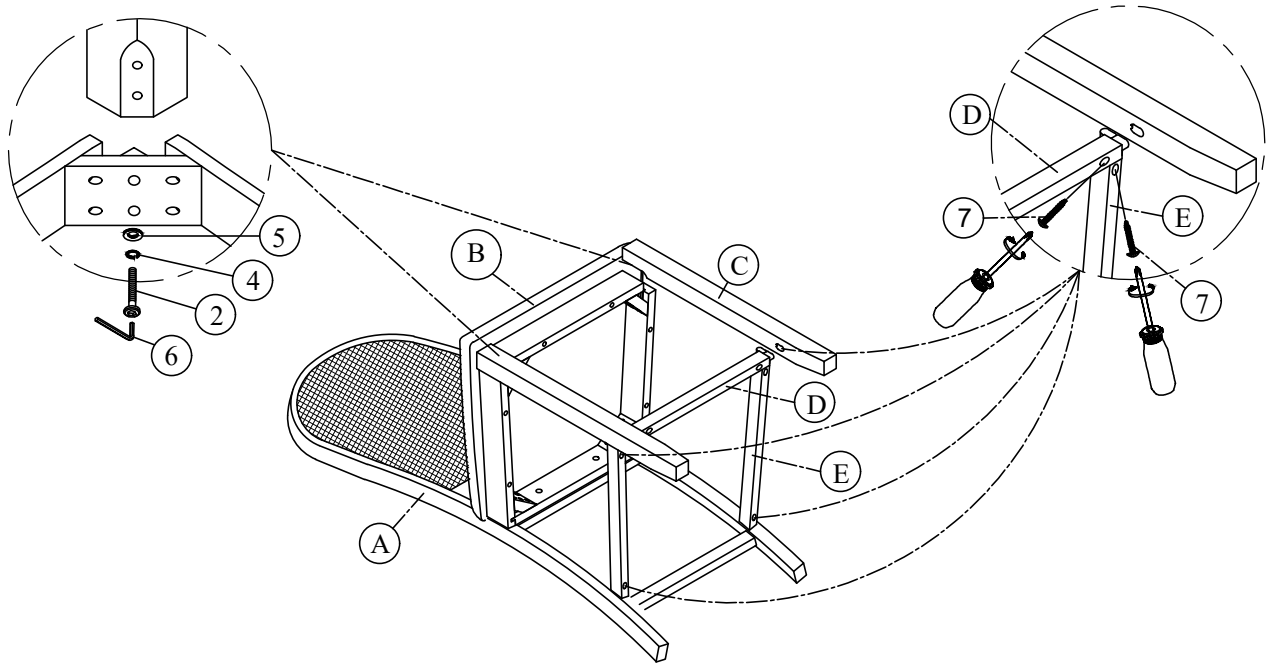

**Step 3:** Place the chair on flat surface and adjust legs so that chair is level and does not wobble. Tighten all bolt and screw. Assembly product is completed.

