















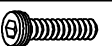

# ASSEMBLY INSTRUCTION

LOT# FPF008TDG ACCENT CHAIR

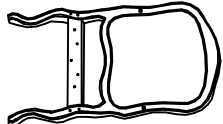
PARTS LIST							
PARTS#	PARTS NAME	DRAWING	QTY	PARTS#	PARTS NAME	DRAWING	QTY
A	FLAT WASHER 5/16"		11	L	PLUG		2
B	LOCK WASHER 5/16"		11	M	FRONT LEG		2
C	BOLTS DIA 5/16"X2-1/2"		8	N	LEFT ACCENT		1
D	BOLTS DIA 5/16"X1-3/4"		3	O	RIGHT ACCENT		1
E	ALLEN WRENCH 5/16"		1	P	CUSHION		1
F	FLAT WASHER 1/4"		4	Q	SEAT FRAME		1
G	LOCK WASHER 1/4"		4	R	CHAIR BACK		1
H	BOLTS DIA 1/4"X1-1/2"		2				
I	BOLTS DIA 1/4"X2-1/4"		2				
J	ALLEN WRENCH 1/4"		1				
K	WOOD SCREW		5				

Note: Do Not tighten bolts until assembly is fully completed.

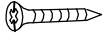
**STEP 1.**

Remove all parts from carton and separate them into part number groups as indicated on the part list. Place the chair back (R) on a smooth flat surface with the holes facing up. Loosely tighten all bolts until instructed to fully tighten at the end of step.

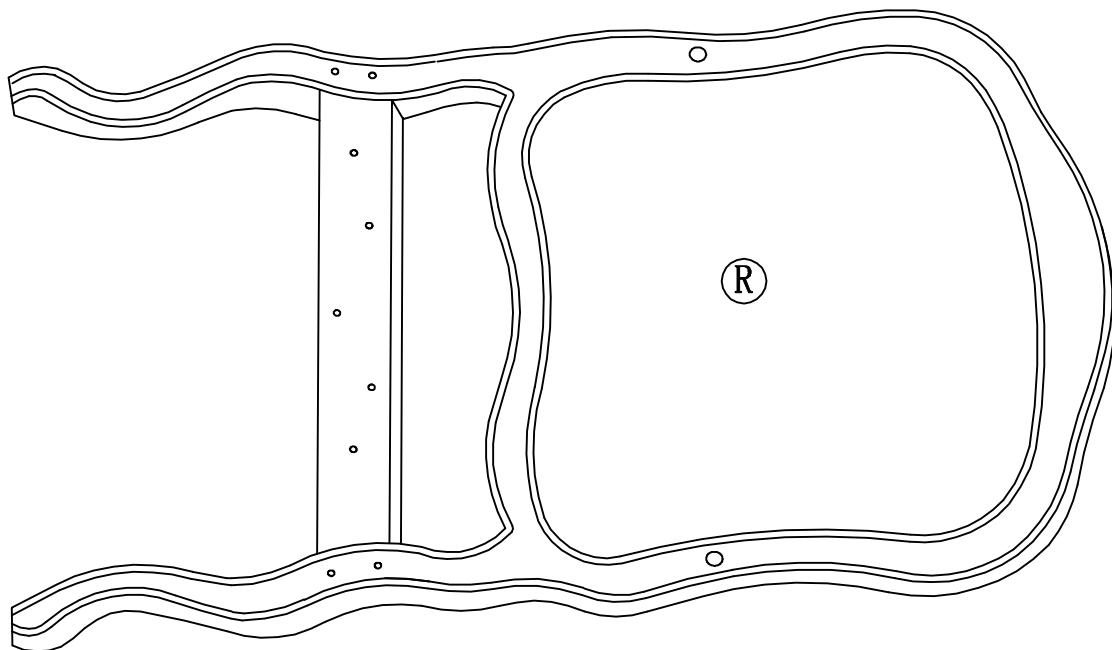

# ASSEMBLY INSTRUCTION

## LOT# FPF008TDG ACCENT CHAIR

### STEP 2.

Attach seat frame (Q) to chair back (R). Insert flat washer (A) lock washer (B) and bolts (D) through center hole of back rail. Insert flat washer (A) lock washer (B) and bolts (C) through corner block to back leg. Use allen wrench (E) to secure bolts (C,D). Tighten slightly not fully.

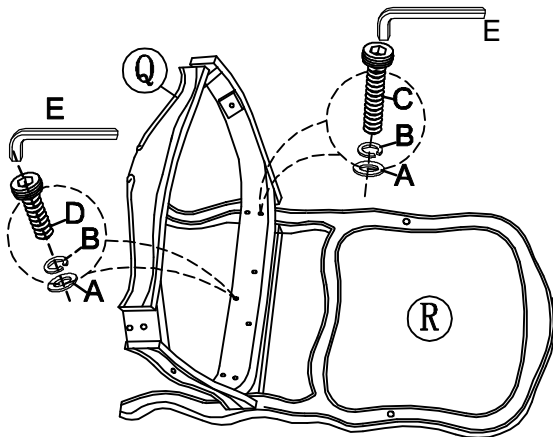

### STEP 3.

Attach front leg (M) to seat frame (Q) using flat washer (A) lock washer (B) and bolts (C). Tighten slightly not fully.

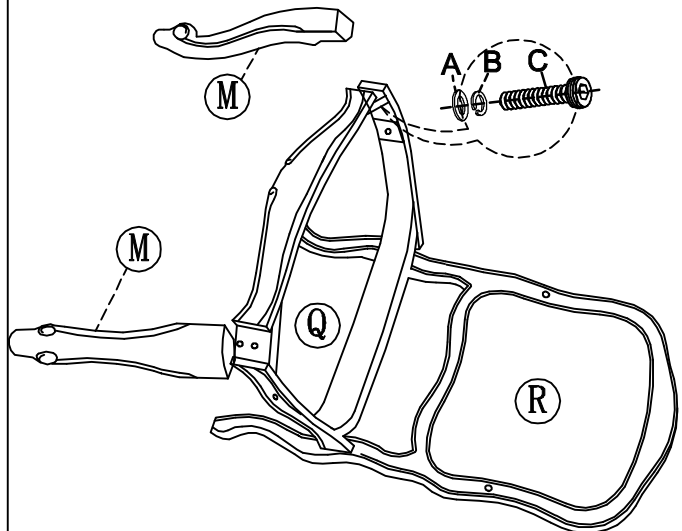

### STEP 4.

Place the cushion (P) on the seat frame (Q). Caution : Use of incorrect bolts in the section could result in damage to the ACCENT. Attach the leaf accent (N) and right accent (O) to the seat frame (Q) with flat washer (F) lock washer (G) and bolts (I) using wrench (J). Attach the leaf accent (N) and right accent (O) to chair back (R) with flat washer (F) lock washer (G) and bolts (H) using wrench (J).

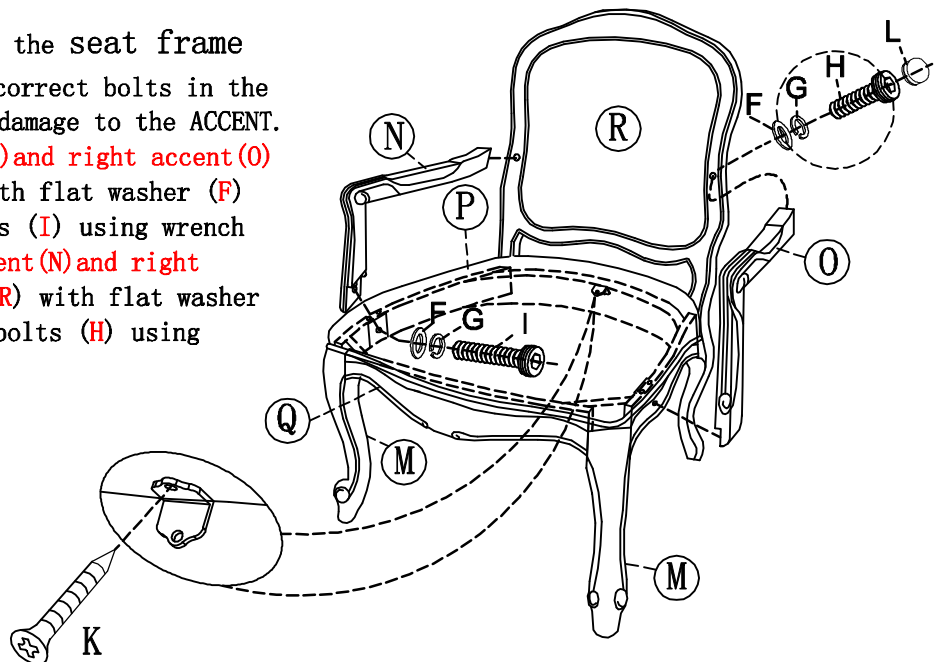

### STEP 5.

Attach Seat Frame (Q) to Cushion (P) using Wood Screw (K). Place chair upright on a level surface & tighten all bolts securely. Insert the plug (L) to the hole of chair back.

Warnings : Failure to observe these warnings can result in serious injury and/or product damage:

- \* Never stand on the chair.
- \* Never use the chair as a ladder.
- \* Do not tip the chair when seated.
- \* Periodically re-tighten all bolts.