

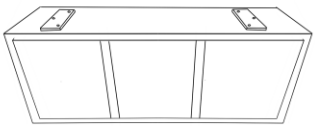







LIVING SPACES

# ASSEMBLY INSTRUCTION 295133 - LARGE SIDEBOARD

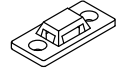
S No.	Name of Component	QTY.
Ⓐ	Carcass / Body 	1
①	Legs 	2
②	Bolts 	6
③	Allen key 	1
④	Bracket 	2
⑤	Tie 	1
⑥	Screw Ø4 X 20 	4

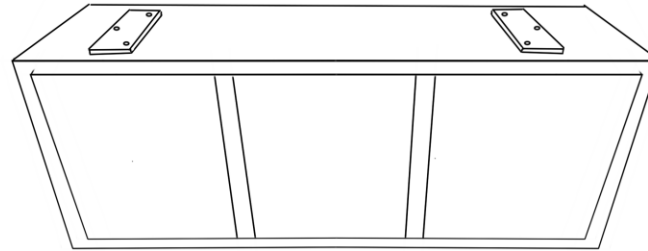

Ⓐ

STEP 1

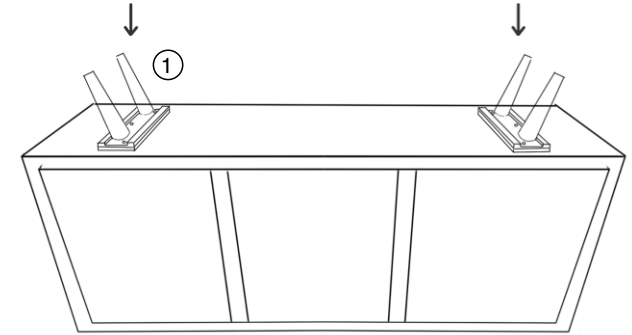

STEP 2

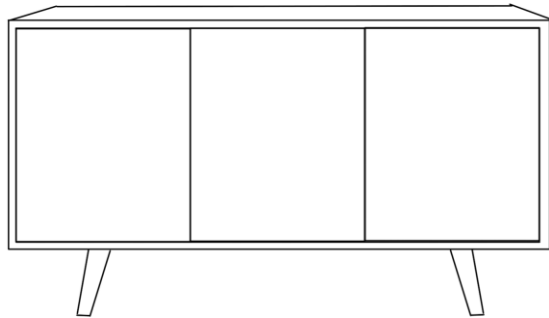

FINAL PRODUCT (FRONT VIEW)

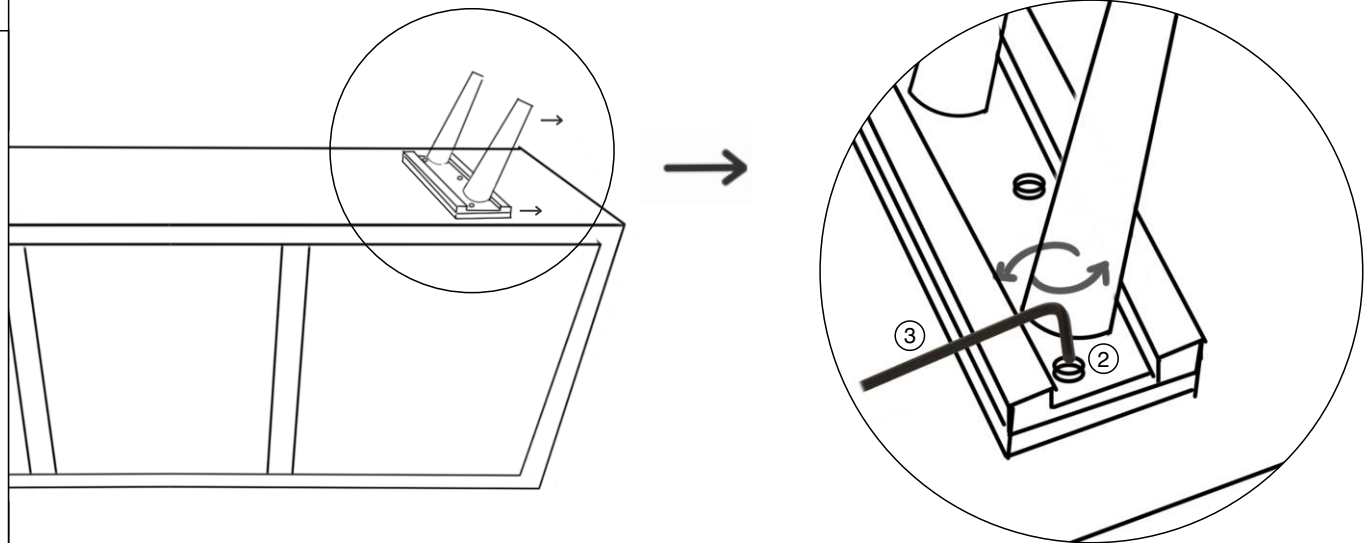







STEP 3

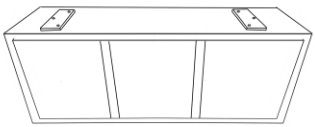

LIVING SPACES

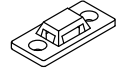
# ASSEMBLY INSTRUCTION 295133 - LARGE SIDEBOARD

S No.	Name of Component	QTY.
Ⓐ	Carcass / Body 	1
①	Legs 	2
②	Bolts 	6
③	Allen key 	1
④	Bracket 	2
⑤	Tie 	1
⑥	Screw Ø4 X 20 	4

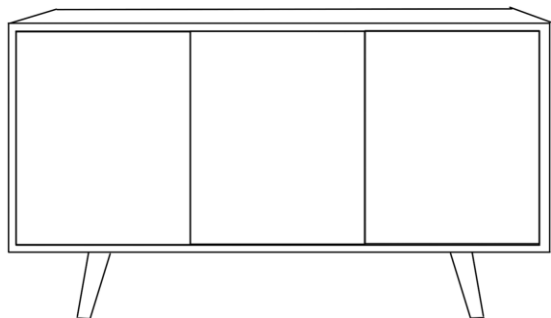

FINAL PRODUCT (FRONT VIEW)

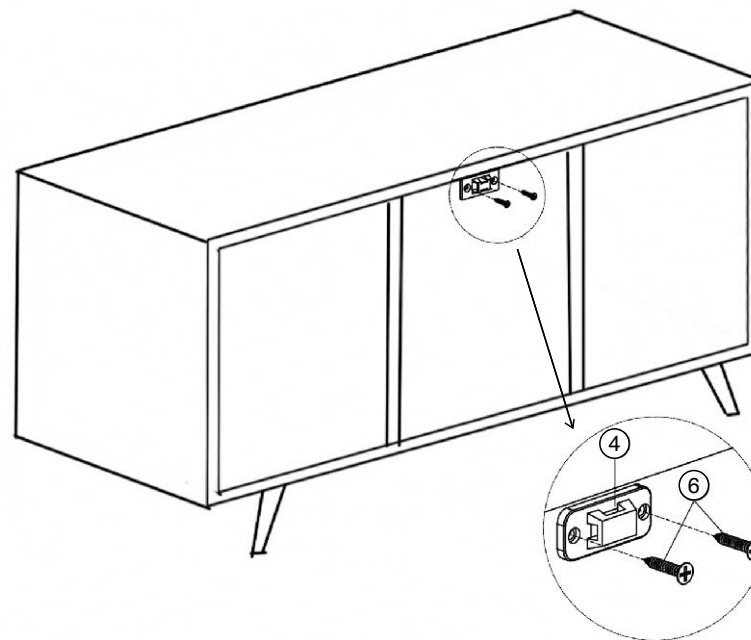

STEP 4

BACK VIEW

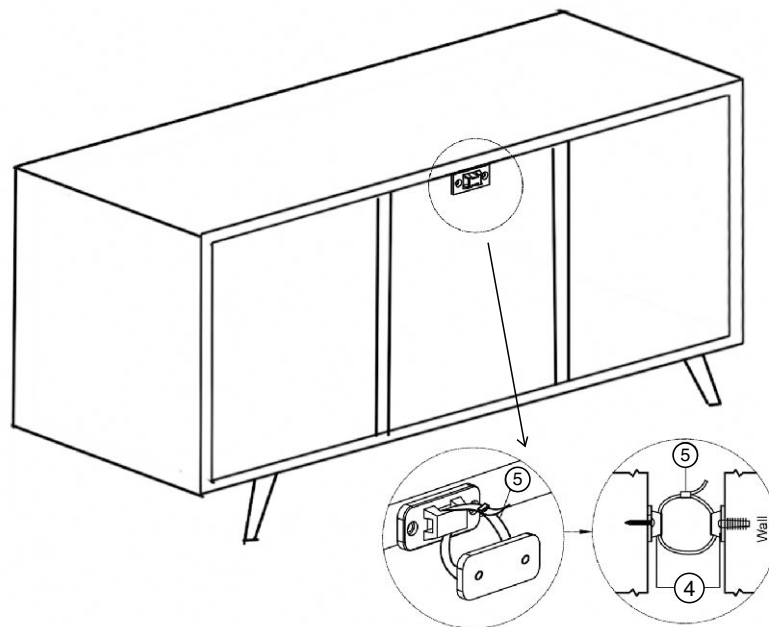

FINAL

BACK VIEW