

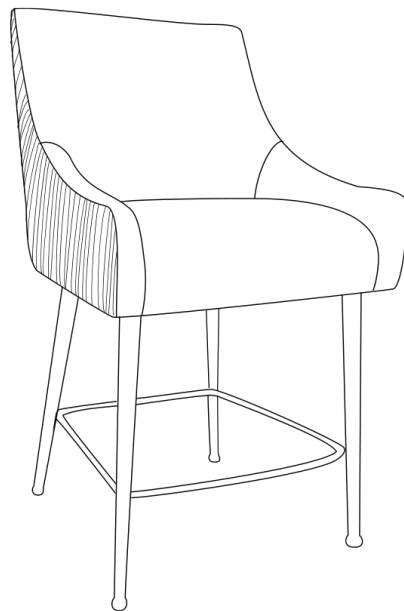



Beatrix Pleated Barstool/Counterstool

BEATRIX



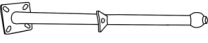

ASSEMBLY INSTRUCTIONS



PARTS LIST

LABEL	PICTURE	DESCRIPTION	QTY
A		Chair Body	1
B		Front Leg	2
C		Back Leg	2
D		Foot rest	1

HARDWARE

LABEL	PICTURE	DESCRIPTION	QTY
E		Metal Gasket	24
F		Spring Washer	16
G		Screw(M6*30)	16
H		Screw(M6*16)	4
I		Wrench	1

BEFORE BEGINNING ASSEMBLY:



Read instructions cover to cover



Have two adults on hand for assembly



Do NOT assemble on flooring or carpet. Assemble on a clean non-marring surface (ex: packing foam)



Save all packaging until assembly is completed

Need a part? Call TOV at 516-888-3355 or email service@tovfurniture.com

ASSEMBLY STEPS

STEP 1

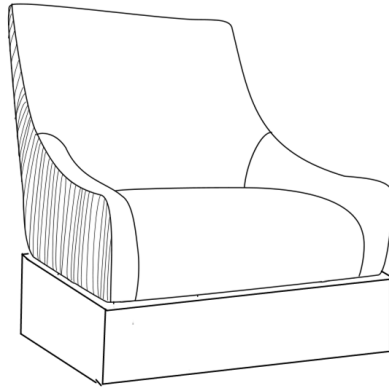

Open the carton to remove the chair body, parts and hardware package.

STEP 2

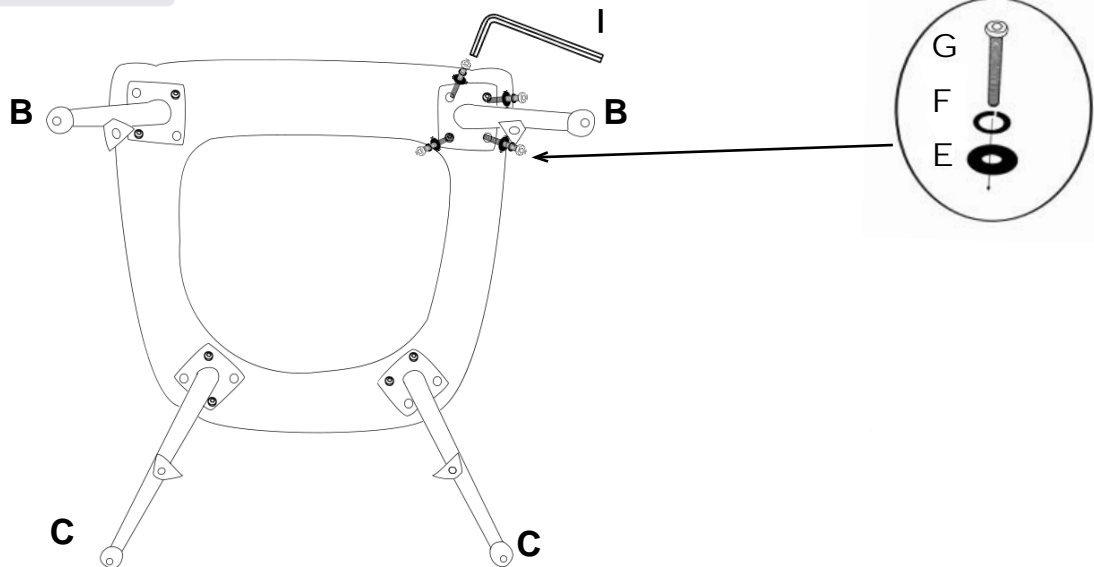

Use provided hardware to attach Leg B and C.
Do not fully tighten them until the last step.

STEP 3

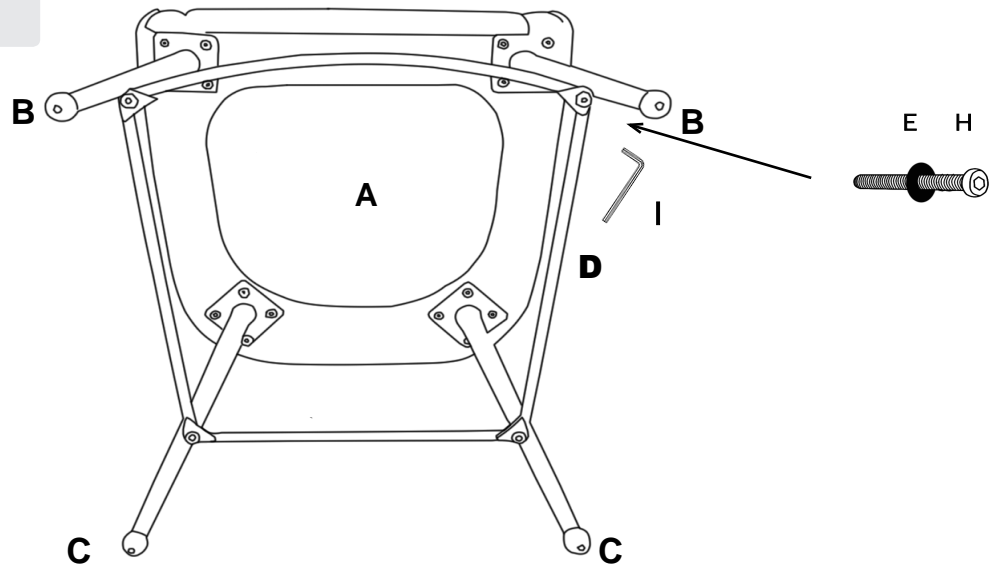

Insert the 4 pcs of Screws (H) into the holes to connect the foot rest. Use Wrench (I) to tighten the Screws (H) clockwise, do not fully tighten until the last step.

STEP 4

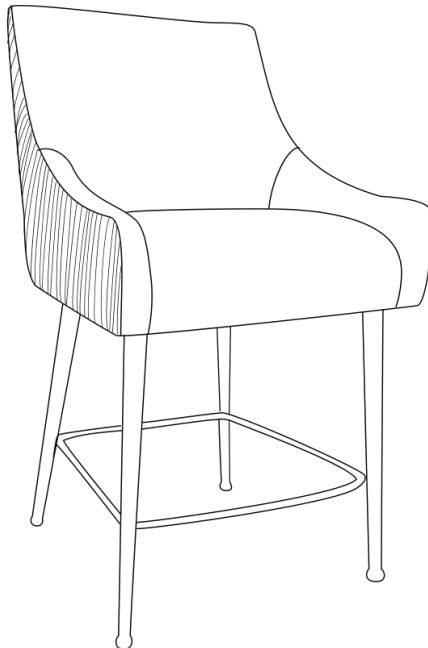

Turn over the barstool/Counterstool and adjust the angle of the legs until they are even.

Fully tighten the Screws(H).

Fully tighten Screws(G) at last.

Assembly is completed.

CARE & MAINTENANCE



Do not put hot items directly on furniture surface.



Do not clean furniture with harsh cleansers or polish.



Dust and pick up spills using a clean, non-colored, lint-free cloth.



Stains may be removed with a mild soap solution and a damp cloth.



Do not place furniture under direct sunlight.



Do not place furniture near heating or cooling vents.



Do not write on furniture without a padded barrier to protect the surface.



Do not place furniture outside, for indoor use only.