











# Halle C/E King Assembly Instructions

Hardware included in headboard carton to attach bed feet and center support system.

A	C	D	E	F	F	G	I	J	K	T
										
Φ6*20 MM	Φ8*50 MM	Φ6 MM	Φ8 MM	H=5 CM	H=5 CM	Metal Slats	Φ8 MM	Center support legs H=11CM	Φ8*80MM	Φ6*25MM
8PCS	12PCS	16PCS	14PCS	2PCS	2PCS	4PCS	1PC	8PCS	2PCS	8PCS

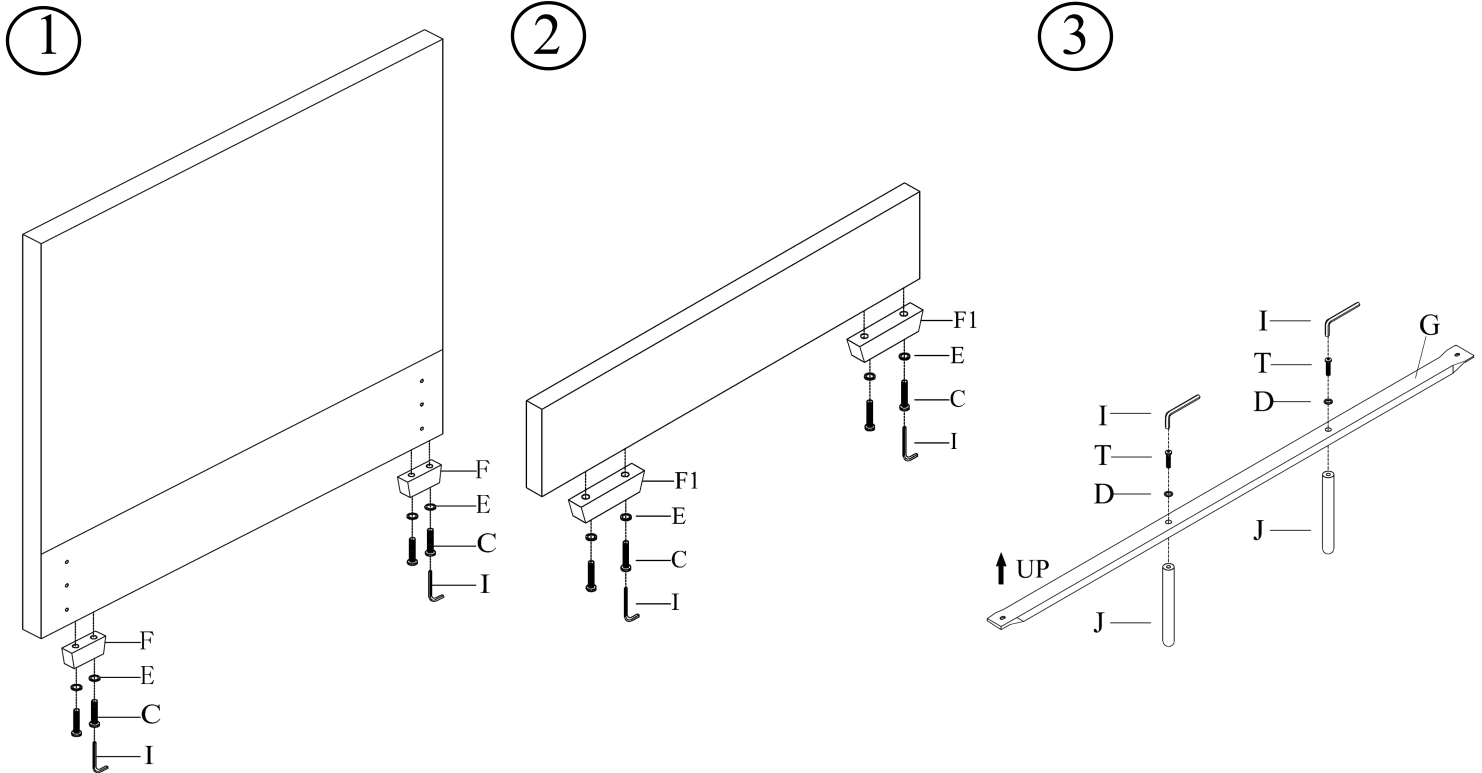

## Step#1

Retrieve bed feet from carton fastened behind the headboard.

Attach bed feet (F) to the headboard using Wrench (I), Bolt (C) and Washer (E).

## Step#2

Attach bed feet (F1) to the footboard using Wrench (I), Bolt (C) and Washer (E).

## Step#3











Attach steel center support legs (J) to the Metal slat (G) using Wrench (I), Bolt (T) and Washer (D).

CONGRATULATIONS ON YOUR NEW BED PURCHASE

~Warning: do not move bed after final assembly as it may result in damages to floor and/or bed.~

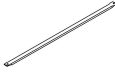
# Halle C/E King Assembly Instructions

Hardware included in headboard carton to attach bed feet and center support system.

A	C	D	E	F	F	G	I	J	K	T
										
Φ6*20 MM	Φ8*50 MM	Φ6 MM	Φ8 MM	H=5 CM	H=5 CM	Metal Slats	Φ8 MM	Center support legs H=11CM	Φ8*80MM	Φ6*25MM
8PCS	12PCS	16PCS	14PCS	2PCS	2PCS	4PCS	1PC	8PCS	2PCS	8PCS

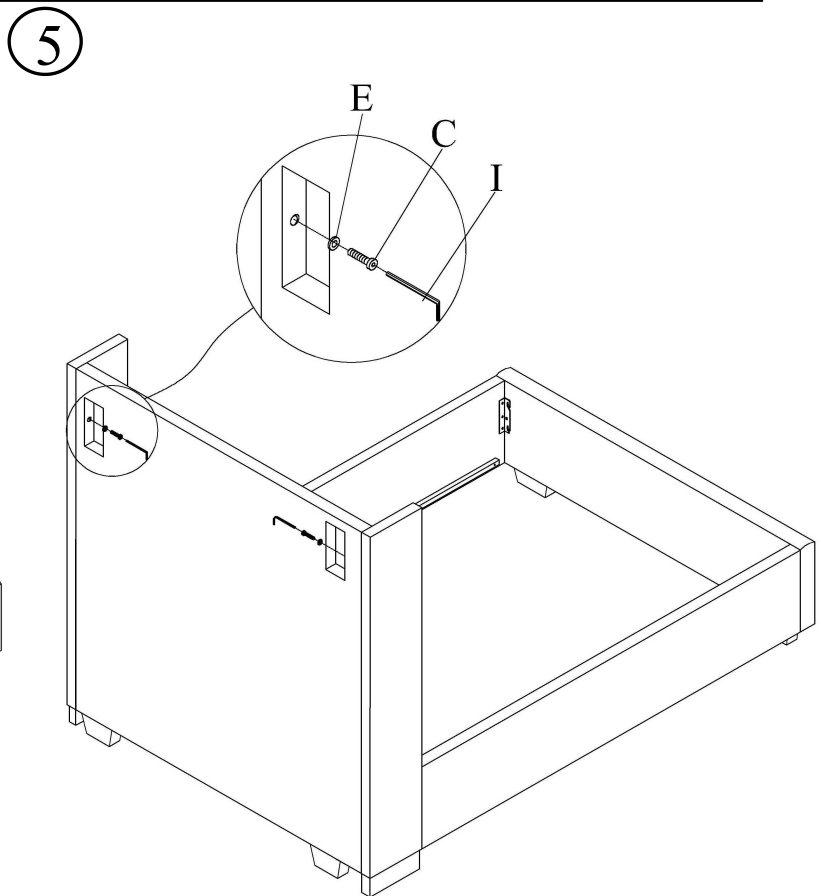
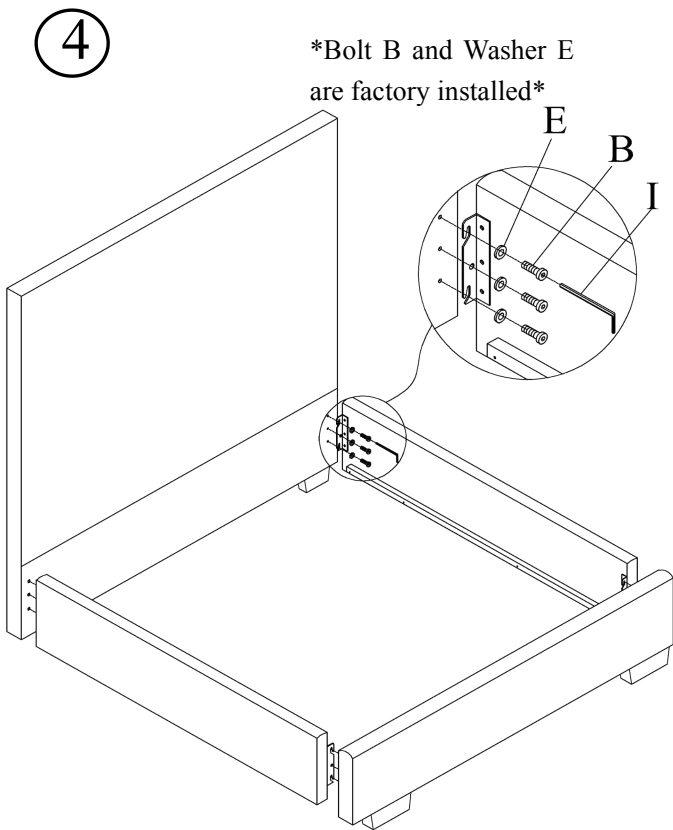

## Step#4

Attach side rails to headboard using Wrench(I), Bolt (B) and Washer (E)(factory installed).

## Step#5











Attach wings through headboard finger tight, using Wrench(I), Bolt (C) and Washer (E).

CONGRATULATIONS ON YOUR NEW BED PURCHASE

~Warning: do not move bed after final assembly as it may result in damages to floor and/or bed.~

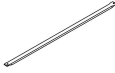
# Halle C/E King Assembly Instructions

Hardware included in headboard carton to attach bed feet and center support system.

A	C	D	E	F	F	G	I	J	K	T
										
Φ6*20 MM	Φ8*50 MM	Φ6 MM	Φ8 MM	H=5 CM	H=5 CM	Metal Slats	Φ8 MM	Center support legs H=11CM	Φ8*80MM	Φ6*25MM
8PCS	12PCS	16PCS	14PCS	2PCS	2PCS	4PCS	1PC	8PCS	2PCS	8PCS

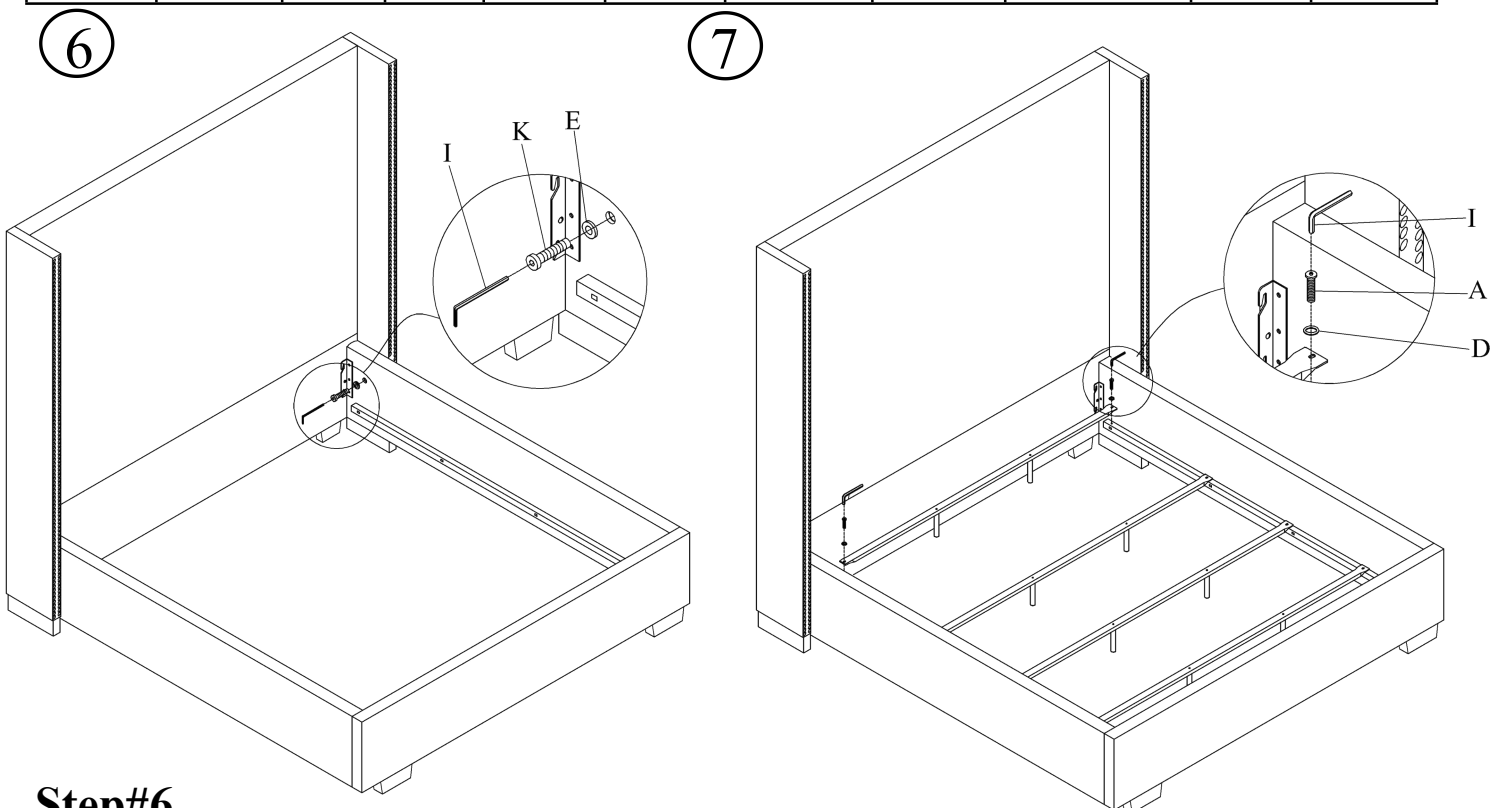

## Step#6

Attach wings through side rail finger tight, using Wrench(I), Bolt (K) and Washer (E)  
Tighten secure wings (6 bolts) with Allen wrench until snug.

## Step#7

Move/place bed into final position in bedroom.

Attach steel slat support system to full length steel side support cleats(flat side facing up).  
Verify the metal slats are installed properly into support cleats and center support legs are perpendicular to the floor for full support.

**CONGRATULATIONS ON YOUR NEW BED PURCHASE**

~Warning: do not move bed after final assembly as it may result in damages to floor and/or bed.~