

TYBEE OUTDOOR COFFEE TABLE 21CT024A Assembly Instruction

Parts List:





REF	PART NAME	PART IMAGE	Q'TY	REF.	PART NAME	PART IMAGE	Q'TY
A	TABLE TOP		1	D	WASHER		8
B	LEG		4	E	ALLEN WRENCH		1
C	BOLT		8				

Diagram:



Assembly Steps:

Step1: Pls remove protective wrapping and lay all parts on the floor. make sure all parts packed in carton against attached parts list are presented.

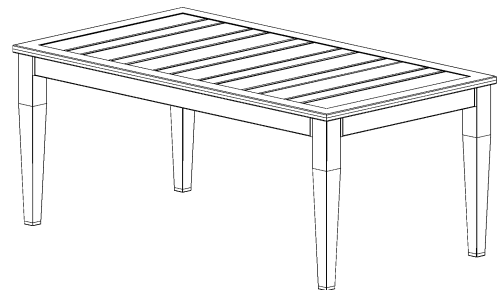
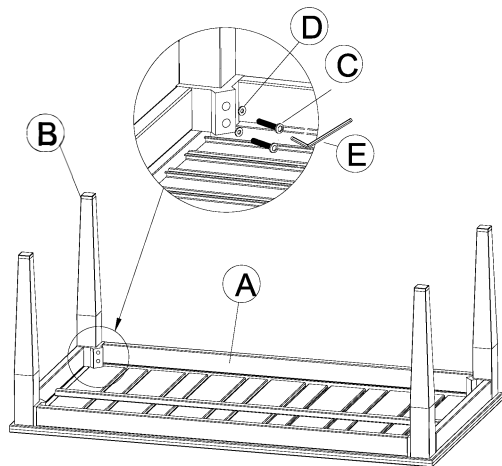
Step2:Place a protective soft material before laying the table top on floor,assemble the coffee table as the above diagram.

Step3:After all parts are aligned and tightened properly,pls turn over the coffee table carefully with a second person's assistance. make sure the legs are on a flat surface.