



ASSEMBLY INSTRUCTIONS



CROWN MARK (CRWN)

MODEL: B9100-Q-HBFB / B9100-K-HBFB

Thank you for purchasing this quality product. Be sure to check all packing material carefully for small parts which may have come loose inside the carton during shipment. Identify and count all parts and compare with hardware list as below:

STEP 1

(BOX 1) BOX OF HEADBOARD			
ITEM	DRAWING	DESCRIPTION	QTY
A		HEAD BOARD	1
B		HB LEG POST (L/R)	2

(BOX 1) BOX OF HEADBOARD (HARDWARE LIST)				
ITEM	DRAWING	DESCRIPTION	DIMENSION	QTY
C		JCBB (M8) WITH WASHER	8 x 35MM (Nyllok)	4
D		ALLEN KEY M5	5 x 35 x 120MM	1

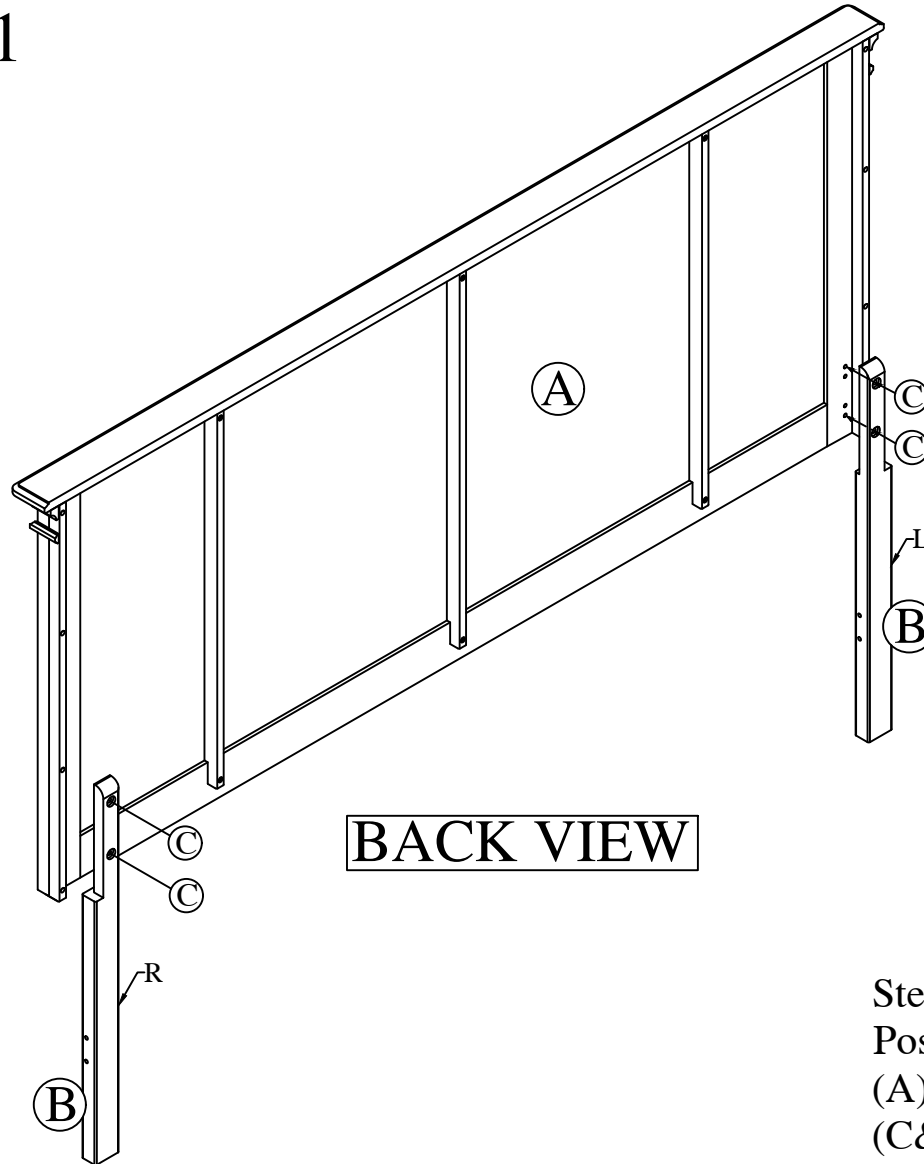
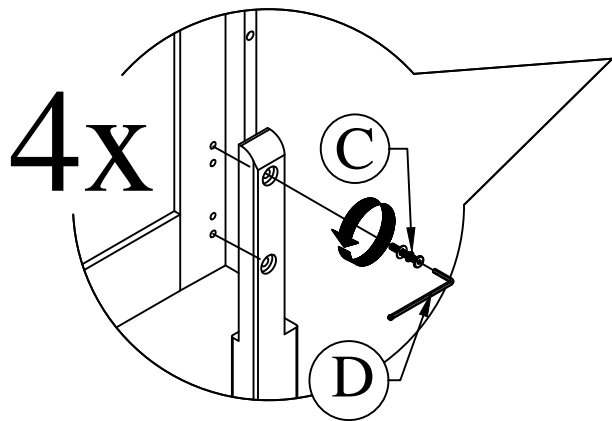

BACK VIEW

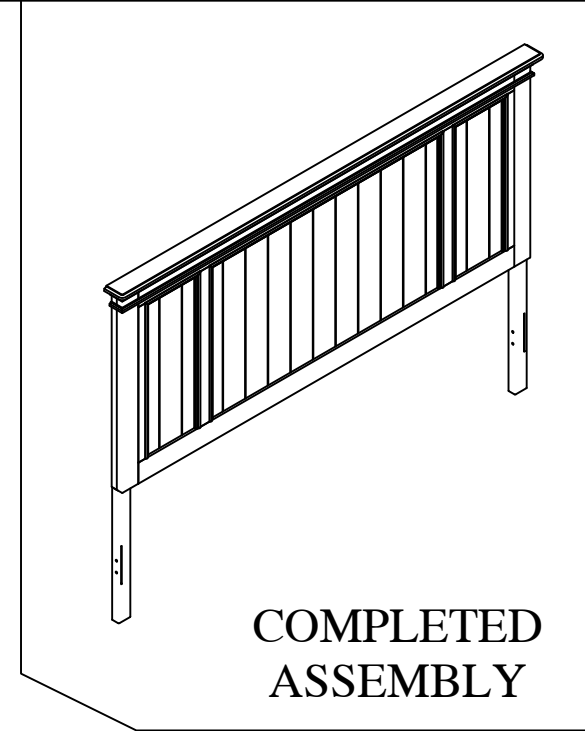

COMPLETED ASSEMBLY

Step 1 : Attach and tighten the Leg Post (L/R) (B) to the Head Board (A). Insert JCBB (M8) With Washer (C&D) to affix.

NOTE: MUST TIGHTEN SCREW PERIODICALLY. WITH USE SCREWS WILL BECOME LOOSE CHECK THIGHT OF ALL SREWS EVERY 6-8 WEEKS.

CLEANING INSTRUCTION

After assembled, clean & polish the complete parts if necessary with soft cloth and industrial recognized furniture polish.

THE HARDWARE IS LOCATED IN THE PACKING ITEMS

MADE IN MALAYSIA

ASSEMBLY INSTRUCTIONS



CROWN MARK (CRWN)

MODEL: B9100-Q-HBFB , B9100-KQ-RAIL

Thank you for purchasing this quality product. Be sure to check all packing material carefully for small parts which may have come loose inside the carton during shipment. Identify and count all parts and compare with hardware list as below:

STEP 1

PART LIST			
(BOX 1) BOX OF HEADBOARD			
ITEM	DRAWING	DESCRIPTION	QTY
A		HEAD BOARD	1

(BOX 2) BOX OF FOOTBOARD			
ITEM	DRAWING	DESCRIPTION	QTY
B		FOOT BOARD	1
C		WOODEN SLAT	4
D		SLATS SUPPORT	4

(BOX 3) BOX OF SIDE RAILS			
ITEM	DRAWING	DESCRIPTION	QTY
E		SIDE RAILS	2

(BOX 2) BOX OF FOOTBOARD HARDWARE LIST				
ITEM	DRAWING	DESCRIPTION	DIMENSION	QTY
F		C.S.K SCREW (M4)	4 x 32mm	8

Screw Driver is not included

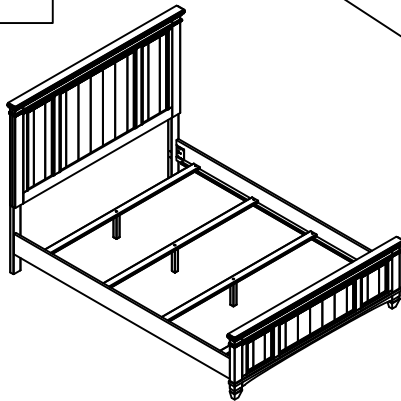
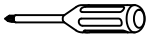

COMPLETED ASSEMBLY

NOTE: MUST TIGHTEN SCREW PERIODICALLY. WITH USE SCREWS WILL BECOME LOOSE CHECK TIGHT OF ALL SREWS EVERY 6-8 WEEKS.
CLEANING INSTRUCTION

After assembled, clean & polish the complete parts if necessary with soft cloth and industrial recognized furniture polish.

STEP 2

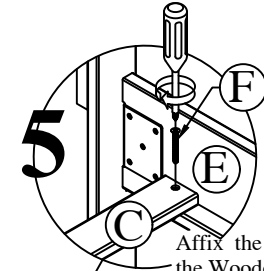
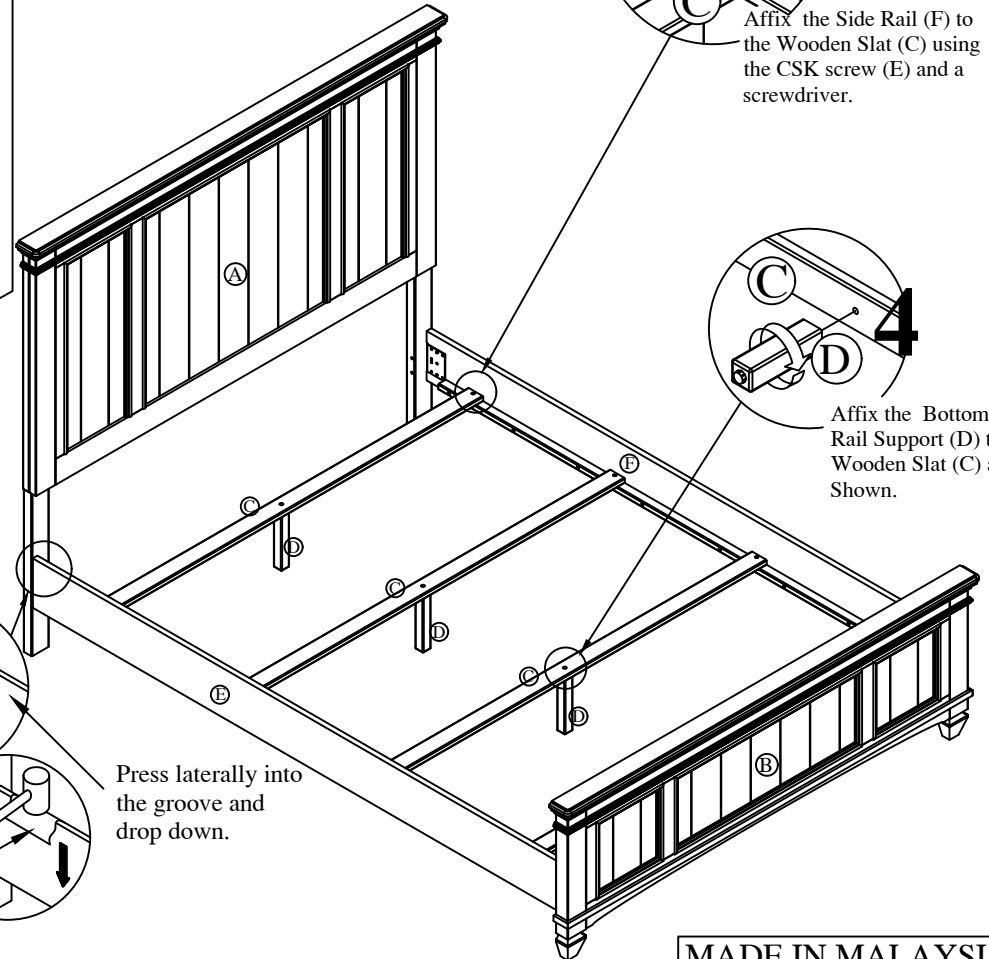
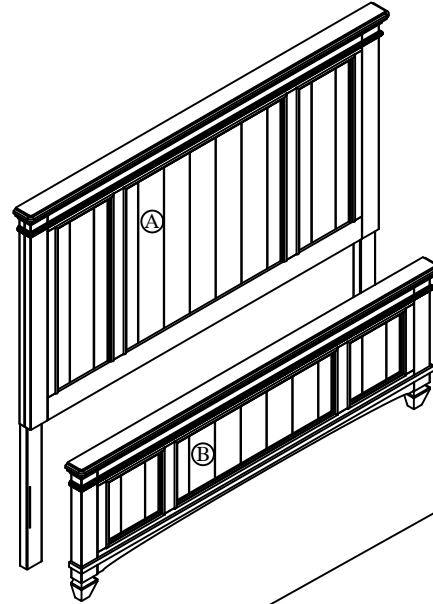

Affix the Side Rail (F) to the Wooden Slat (C) using the CSK screw (E) and a screwdriver.

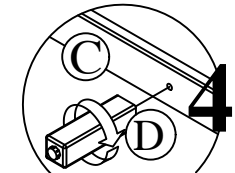

Affix the Bottom Rail Support (D) to Wooden Slat (C) as Shown.

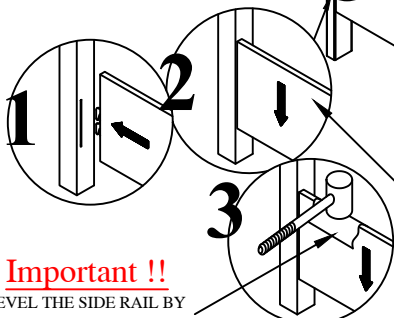

Press laterally into the groove and drop down.

Important !!

LEVEL THE SIDE RAIL BY COVERING WITH A SOFT CLOTH AND TAPPING WITH A HAMMER.

MADE IN MALAYSIA

THE HARDWARE IS LOCATED IN THE PACKING ITEMS