



ASSEMBLY INSTRUCTIONS



CROWN MARK (CRWN)

MODEL: B9100-4 SAWYER CHEST

Thank you for purchasing this quality product. Be sure to check all packing material carefully for small parts which may have come loose inside the carton during shipment. Identify and count all parts and compare with hardware list as below:

STEP 1

(BOX 1) BOX OF CHEST			
ITEM	DRAWING	DESCRIPTION	QTY
A		CHEST	1
B		BOTTOM LEG	4

(BOX 1) BOX OF CHEST (HARDWARE LIST)				
ITEM	DRAWING	DESCRIPTION	DIMENSION	QTY
C		JCBB (M8) WITH WASHER	8 x P1.0 x 50MM	4
D		ALLEN KEY M5	5 x 35 x 55MM	1

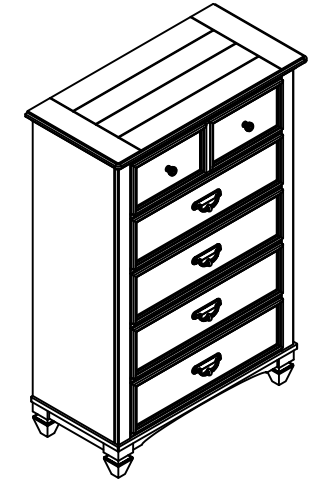
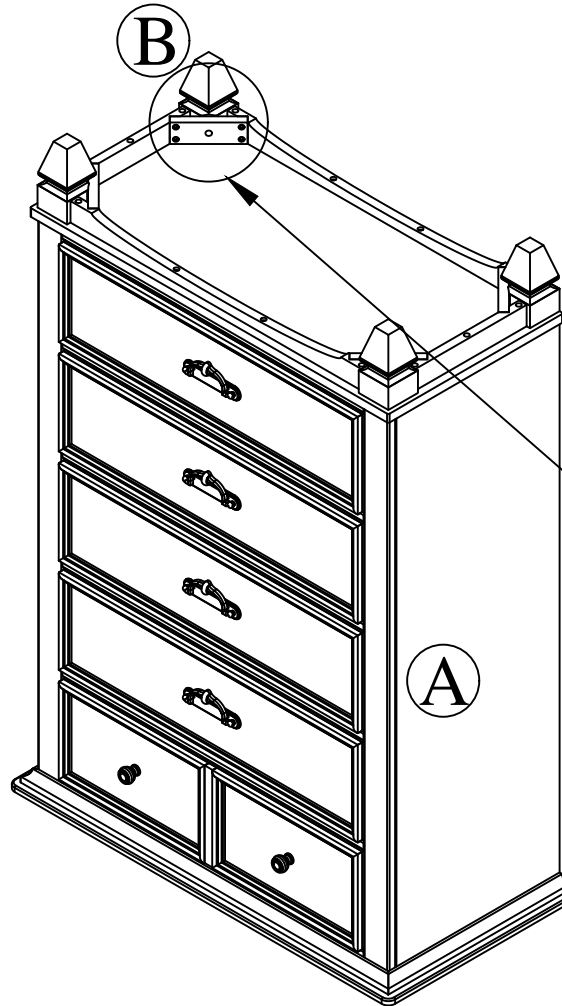

COMPLETED ASSEMBLY

Step 1 : Attach and tighten the CHEST bottom leg (B) to the bottom frame and insert JCBB (C) With Washer (D) as shown.

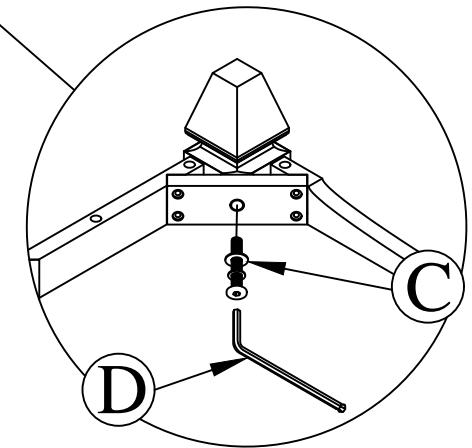

NOTE: MUST TIGHTEN SCREW PERIODICALLY. WITH USE SCREWS WILL BECOME LOOSE CHECK TIGHT OF ALL SCREWS EVERY 6-8 WEEKS.
CLEANING INSTRUCTION

After assembled, clean & polish the complete parts if necessary with soft cloth and industrial recognized furniture polish.

THE ANTI TIPPING HARDWARE IS LOCATED IN THE CHEST FIRST DRAWER

THE HARDWARE IS LOCATED IN THE PACKING ITEMS

MADE IN MALAYSIA